

BeoCenter 6–26

Reference book

Tables of contents in the Reference book

The contents of this Reference book is divided into sections. Each particular section starts with its own detailed table of contents provided with page references. Texts in black refers to the current section, whereas the remaining sections are described in general terms and written in grey.

The main sections are:

- Advanced operation
- Tuning and preference settings
- Placement, sockets and connections
- BeoLink system
- Index

Menu overview

The illustration on this page shows the content of the menu system, and also indicates where in the Reference book you can find further information about the menus.

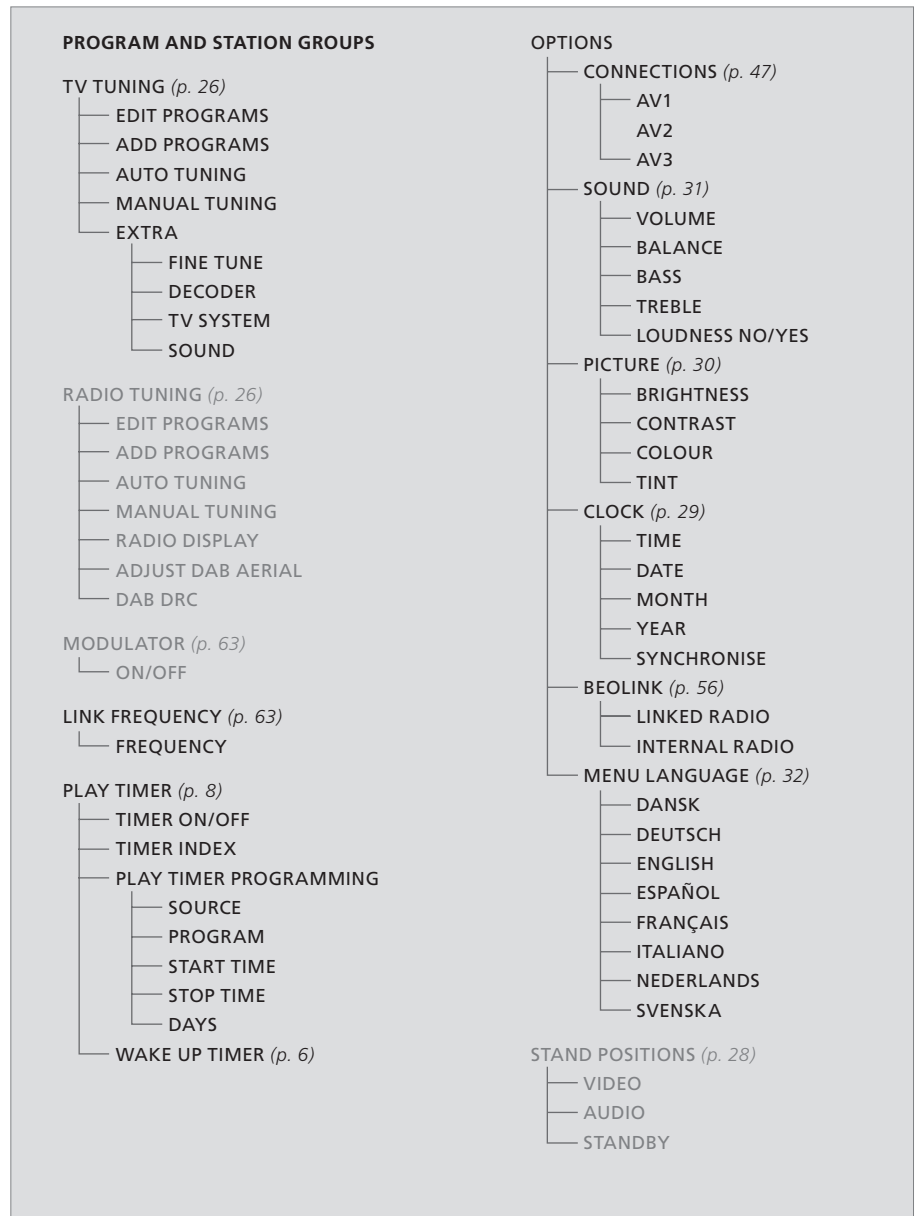

The extended on-screen menu system for the television. The presence of the greyed menu items depends on whether these optional extras are available in your system.

Press MENU on Beo4 to access the main menu.

This chapter tells you how to operate your television beyond daily use.

It also tells you how to operate a connected set-top box and other connected video equipment.

- **Wake-up Timer, 6**
- **Set the television to switch itself on and off, 8**
- **Set-top box operation, 10**
- **Use your television as a computer monitor, 12**
- **Surround sound, 13**

Tuning and preference settings, 15

Find out how to set up your television for the first time and tune in programs. This chapter also contains information about settings for time, date, stand positions, picture and sound.

Placement, sockets and connections, 35

Find out how to handle and place your television and where the sockets are placed. Find out how to connect a decoder, set-top box or video recorder to your television and how to register extra equipment. How to connect speakers and how to turn your television into a surround sound system, including how to choose speaker combinations.

BeoLink system, 55

Find out how to connect an audio system to your television and operate an integrated audio/video system. Find out how to make link connections, operate a link system and set up your television in a link room. Find out How to customise Beo4 to your system.

Index, 68

Wake-up Timer

You can make the television wake you up in the morning.

The Wake-up Timer is a once-only Timer, it lasts for one hour. Like an alarm clock, it is disabled once it has been executed. It applies only to the television it has been programmed on.

Once you have made one Wake-up Timer, the television automatically suggests the time you entered for the latest Wake-up Timer when you enter a new one.

Wake-up Timers can, of course, also be disabled again.

When you have programmed a Wake-up Timer, the television cannot be part of an ordinary Play Timer or Standby Timer until the Wake-up Timer has been carried out or disabled.

Enter a Wake-up Timer

You must choose the source and program number of your Wake-up Timer as well as the start time.

To enter settings for a Wake-up Timer ...

- > Press **MENU** to bring up the TV SETUP menu and press ▼ to highlight PLAY TIMER.
- > Press **GO** to bring up the PLAY TIMER menu and press ▼ to highlight WAKE UP TIMER.
- > Press **GO** to bring up the WAKE UP TIMER menu.
- > Press ▲ or ▼ to move through the menu items.
- > Use the number buttons to enter information or press ◀ or ▶ to view your choices for each item.
- > When you have filled in the required information, press **GO** to store your Wake-up Timer.
- > Press **EXIT** to exit all menus.

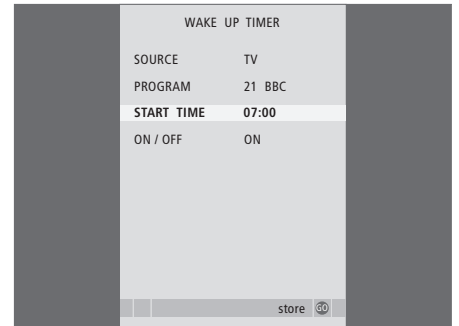

What's on the WAKE-UP TIMER menu ...

- SOURCE ...** Choose the source for your Wake-up Timer from the available sources in your system.
- PROGRAM (Program number) ...** Choose the program number you want.
- START TIME ...** Key in the time when you want the system to start playing.
- ON/OFF ...** Activate or deactivate your Wake-up Timer. Choose ON to activate and OFF to deactivate.

Check or delete a Wake-up Timer

You can call up the settings for the Wake-up Timer to check the time or to disable the Wake-up Timer by setting it to OFF.

To change settings for a Wake-up Timer or delete it ...

- > Press **MENU** to bring up the TV SETUP menu and press ▼ to highlight PLAY TIMER.
- > Press **GO** to bring up the PLAY TIMER menu and press ▼ to highlight WAKE UP TIMER.
- > Press **GO** to bring up the WAKE UP TIMER menu.
- > Press ▲ or ▼ to move through the menu items.
- > Use ◀ or ▶ to change settings or enter a new time with the number buttons. Change the ON/OFF setting to OFF if you wish to delete the Wake-up Timer.
- > When you have made your changes, press **GO** to store them.
- > Press **EXIT** to exit all menus.

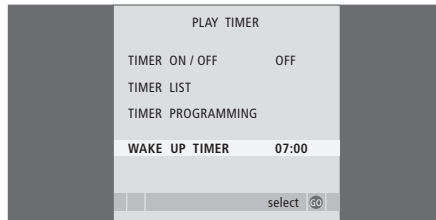

Set the television to switch itself on and off

You can make your television switch itself on and off automatically via the timed play and timed standby functions, if, for example, there is a programme you do not want to miss.

Enter as many as six Timer settings, and bring up an on-screen list of the Timer settings you have entered.

From this list, you can edit or delete your Timer settings.

If your television is integrated with a Bang & Olufsen audio system with a Master Link cable, these systems can perform the timed play or timed standby functions as well.

For your timed settings to be executed correctly, ensure that the built-in clock is set to the correct time. For further information, refer to the chapter 'Set the time and date' on page 29.

Before you start ...

If you connect a Bang & Olufsen audio or video product to your television with a Master Link cable, you can exclude or include it in timed functions via the *Play Timer* menu. For example, set the television's Play Timer to ON and an audio system's Play Timer to OFF if you wish timed functions to apply only to the television.

To switch on the Play Timer ...

- > Press **MENU** to bring up the TV SETUP menu and press **▼** to highlight PLAY TIMER.
- > Press **GO** to bring up the PLAY TIMER menu, and press **▼** or **▲** to highlight TIMER ON/OFF.
- > Press **GO** to bring up the TIMER ON/OFF menu.
- > Press **◀** or **▶** to reveal ON.
- > Press **GO** to store the setting.

For further information about how to switch the Play Timer on or off for a connected Bang & Olufsen audio or video product, refer to the Guide enclosed with the product.

Timed play and timed standby

You can preset your television to start and stop automatically at the same time and day every week.

To enter settings for timed play or timed standby ...

- > Press **MENU** to bring up the TV SETUP menu and press **▼** to highlight PLAY TIMER.
- > Press **GO** to bring up the PLAY TIMER menu and press **▼** to highlight PLAY TIMER PROGRAMMING.
- > Press **GO** to bring up the PLAY TIMER PROGRAMMING menu.
- > Press **▲** or **▼** to move through the menu items.
- > Use the number buttons to enter information or press **◀** or **▶** to view your choices for each item. When DAYS is highlighted, press **▶** once to be able to move through the days, and press **▲** or **▼** to remove a day you do not want. Press **▶** to move to the next day, and press **◀** to move back to a previous day. When the weekday(s) you want are displayed, press **GO** to accept the day(s).
- > When you have filled in the required information, press **GO** to store your Timer settings.
- > Press **EXIT** to exit all menus.

NOTE! If your television is set up in a link room, Timer programming must be carried out on your main room system.

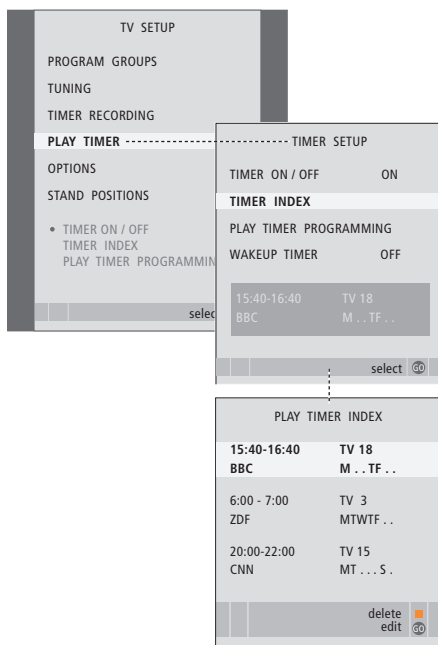

Abbreviations for days of the week:

| | |
|-------|-----------|
| M ... | Monday |
| T ... | Tuesday |
| W ... | Wednesday |
| T ... | Thursday |
| F ... | Friday |
| S ... | Saturday |
| S ... | Sunday |

View, edit or delete a Timer

Bring up an on-screen list of the settings you have entered. From this list, you can edit or delete your Timer settings.

To view, edit or delete your Timer settings ...

- > Select **TIMER INDEX** from the **TIMER SETUP** menu to bring up your list of Timer settings. The first Timer setting in the list is already highlighted.
- > Press **▲** or **▼** to move the cursor to a Timer setting you wish to edit.
- > To edit a setting, press **GO** and follow the procedure described to the left.
- > To be able to delete a selected setting, press the yellow button.
- > If you change your mind, press **◀** to move the setting back into the list. You can also press **EXIT** to exit all menus.
- > Press the yellow button a second time to delete the setting.

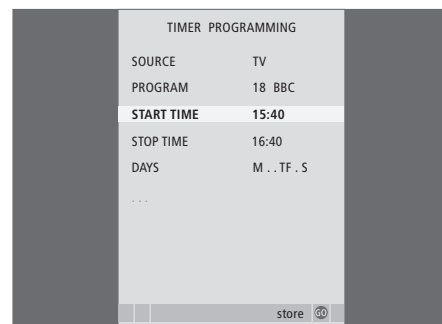

What's on the **TIMER PROGRAMMING** menu ...

SOURCE

Choose the source for your Timer from the available sources in your system. Choose **STANDBY**, if you want the television to switch off. If you have other compatible video or audio systems connected to your television, they are switched off as well.

PROGRAM (Program number) ... Once your source is chosen, choose the program number you want.

START TIME and **STOP TIME** ... Key in the times when you want the system to start and/or stop playing. If you have set the Timer source to **STANDBY**, it is only possible to enter a stop time.

DAYS ... Select the specific weekday(s) on which you want your Timer executed. All the weekdays will be displayed – starting with M for Monday.

You can only use a source, such as A.MEM, if it is present in your setup.

Set-top box operation

The built-in Set-top Box Controller acts as an interpreter between a set-top box of your choice and the Beo4 remote control. When a set-top box is connected, you can use the Beo4 remote control to gain access to the programs and functions offered by your set-top box.

Some functions are immediately available via Beo4 when you switch on the set-top box. Additional functions are available through a Set-top Box Controller menu that you bring up on the screen.

Set-top Box Controller menu

Some of the buttons on your set-top box remote control are not immediately available on Beo4. To find out which Beo4 buttons activate specific services or functions in your set-top box, bring up the Set-top Box Controller menu on the screen.

Press to switch on the set-top box **DTV**

Press to bring up the Set-top Box Controller menu **MENU**

Press the number button that activates the function you want, or ... **1 – 9**

... press one of the coloured buttons to activate a function

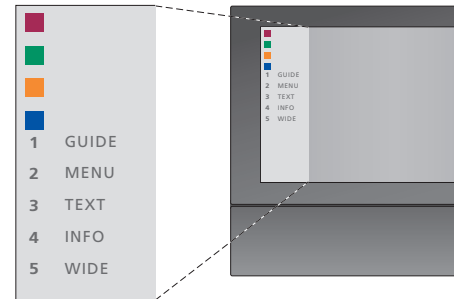

Example of a Set-top Box Controller menu – The Beo4 buttons are shown to the left on the menu and the set-top box buttons are shown to the right.

NOTE! If your television is equipped with the optional DVB module, you activate a connected set-top box with the V.AUX cue in the Beo4 display. If no DVB module is fitted, you activate your set-top box with the DTV button.

Universal Beo4 operation

If you know which Beo4 button activates the function you want, you can activate the function without bringing up the Set-top Box Controller menu first.

While your set-top box is activated ...

Press GO and then the number **GO**
1 – 9
button that activates the
function you want

Press one of the coloured 
buttons to activate a function

Press GO and then **GO**
▲ or **▼** to
step up or down through
programs directly

Press and hold GO to bring up **GO**
the Program guide or the 'Now/
Next' banner on the screen
depending on your set-top box

Use the set-top box's own menu

Once you have activated your set-top box, you can operate the set-top box's own menus, such as the program guide, via Beo4.

While the set-top box's own menu is shown ...

Moves the cursor up or down **▲**
▼

Moves the cursor left or right **◀▶**

Selects and activates a function **GO**
GO

Press GO and then **GO**
◀▶ to
step between menu pages or
step in program lists

Exits menus, or returns to a **STOP**
previous menu*

Exits menus, enters or exits **EXIT**
different modes, such as radio

Use the coloured buttons as 
indicated in the menus of your
set-top box

**Depending on your set-top box,
you may have to press EXIT twice
instead of STOP to return to a
previous menu.*

*When set-top box is selected as
source, press MENU twice to
bring up the television's main
menu.*

Use a set-top box in a link room

When your set-top box is connected to the television in the main room, you can operate the set-top box from the link room television. However, the Set-top Box Controller menu cannot be displayed on the television screen in the link room.

Press to switch on the set-top **DTV**
box in the main room

Press GO and then the number **GO**
button that activates the **1 – 9**
function you want

Press one of the coloured 
buttons to activate a function

Use your television as a computer monitor

If you connect your television to a computer, as described on page 41, you can use it as a monitor.

IMPORTANT! If you wish to connect a computer to the television and use the television as a monitor, make sure that you disconnect the television, the computer, and all equipment connected to the computer from the mains before you connect the computer and the television to each other.

When in use, the computer must be connected to a grounded wall outlet as specified in the computer's setting-up instructions.

Bring up the computer image on the screen

To see the computer picture on the television screen, you must bring it up with Beo4.

To bring up the computer picture ...

Press repeatedly until PC appears in the Beo4 display

Press to bring up the picture

You can then operate the computer as you normally would.

LIST

PC

GO

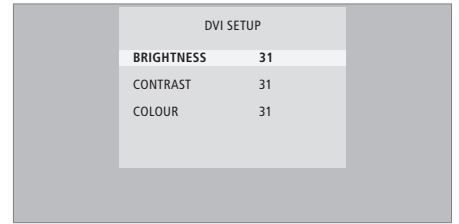

When you have the computer picture on the screen, you must call up the DVI SETUP menu to make adjustments to brightness, contrast and colour.

Picture adjustments ...

- > Press **MENU** to bring up the DVI SETUP menu.
- > Press **▲** or **▼** to move between the menu options.
- > Press **◀** or **▶** to adjust settings.
- > Press **GO** to store your settings and exit the menu.

The settings you make in this menu only apply to the PC setup.

If your television is equipped with the optional surround sound module, you can extend your system in to a surround sound system by adding four Bang & Olufsen loudspeakers and a BeoLab 2 subwoofer*.

When you switch on one of the sources, speakers in a surround sound system can be cut in or out, depending on what kind of sound suits the source you are using.

Select speakers for movie sound

You can select the speaker combination that suits the source you are using, provided that the various sound modes are available in your system.

Press repeatedly to display SPEAKER on Beo4

LIST

SPEAKER

Press the number of the speaker combination you want. The selected speakers cut in automatically

1 – 5

Press to adjust the balance between the front and rear speakers

▲

▼

Press to adjust the balance between the left and right speakers

◀ ▶

Press to remove SPEAKER from the Beo4 display and return to the source you were using

EXIT

If you have added only two front speakers to the television, you will only be able to choose SPEAKER 1–3.

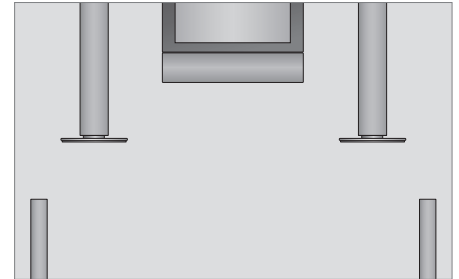

Speaker combinations

SPEAKER 1 ... Sound in the centre speaker only.

SPEAKER 2 ... Stereo sound in the two front speakers. The BeoLab 2 subwoofer is active.

SPEAKER 3 ... The centre speaker, front speakers and the BeoLab 2 subwoofer are active.

SPEAKER 4 ... Enhanced stereo sound in the front and rear speakers. The BeoLab 2 subwoofer is active.

SPEAKER 5 ... Surround sound from all speakers including the BeoLab 2 subwoofer. For programmes encoded in Surround Sound.

SPEAKER 4 and 5 are only available if your television is equipped with the optional surround sound module.

*NOTE! For further information about how to connect speakers to the television, refer to the chapter 'Loudspeaker setup – surround sound' on page 48.

Find out how to perform the first-time setup procedure and tune in all available programs automatically. In addition, you can find information about how to edit tuned programs and adjust other available settings, such as time, date, picture and sound.

For information about how to place your television and connect additional video equipment, refer to the chapter '*Placement, sockets and connections*' on page 35.

Advanced operation, 5

All you need to know about using your television beyond daily use, such as how to operate timed play and timed standby functions, and a connected set-top box. How to operate a surround sound system.

Tuning and preference settings, 15

- **First-time setup of your television, 16**
- **Edit tuned programs, 20**
- **Re-tune or add programs, 26**
- **Set positions for the television to turn to, 28**
- **Set the time and date, 29**
- **Adjust picture and sound settings, 30**
- **Choose menu language, 32**
- **Choose radio display, 33**

Placement, sockets and connections, 35

Find out how to handle and place your television and where the sockets are placed. Find out how to connect a decoder, set-top box or video recorder to your television and how to register extra equipment. How to connect speakers and how to turn your television into a surround sound system, including how to choose speaker combinations.

BeoLink system, 55

Find out how to connect an audio system to your television and operate an integrated audio/video system. Find out how to make link connections, operate a link system and set up your television in a link room. How to customise Beo4 to your system.

Index, 68

First-time setup of your television

The setup procedure described here is activated only when the television is connected to the mains and switched on for the first time.

You must select the menu language, register any extra equipment you have connected, choose radio display, determine the centre position for the motorised stand – if your television is equipped with one – and start the automatic tuning of TV and radio programs.

Select menu language

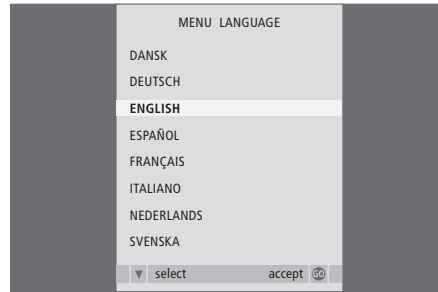

The first time you switch on your television, you must select which language you want all the menus to be displayed in.

*The menu language setup appears. If you wish to change the menu language at a later date, you can find the item under **OPTIONS** in the **TV SETUP** menu.*

- > Press **TV** to switch on the television. The language menu appears.
- > Press **▲** or **▼** to move between the displayed languages, if necessary.
- > Press **GO** to store your choice.

Register extra equipment before auto-tuning

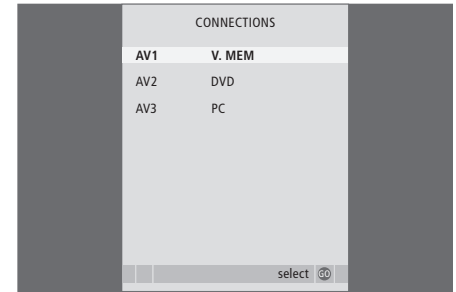

Some extra equipment is detected by the television automatically. You can check and confirm the registration of the equipment involved.

*When the **CONNECTIONS** menu appears ...*

- > Press **▲** or **▼** to step between the different socket groups: AV1, AV2 and AV3.
- > Press **GO** to be able to register a connected product to the highlighted socket group.
- > Press **▲** or **▼** to move between the sockets in the group.
- > Press **◀** or **▶** to register what you have connected to the highlighted socket.
- > Press **GO** to be able to select another socket group.
- > When you have completed your settings, press the green button to store the setup.

NOTE! The described functions of FM and DAB radio are only available if your television is equipped with the optional FM module or the FM/DAB module.

Select radio display

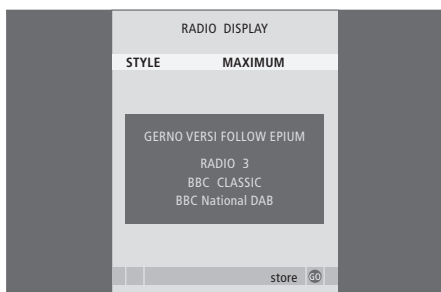

Before tuning in programs, you are prompted to select the display type you want to appear on the television screen when you select radio as your source.

When the DISPLAY SETUP menu appears ...

- > Press ◀ or ▶ to switch between available settings. The chosen display type is shown in the menu as you change settings.
- > Press GO to store your choice.

Store all programs and settings



When you have made your selections, a menu for program tuning automatically appears on the screen.

When the menu for auto tuning appears, the prompt CHECK AERIAL CONNECTION appears to remind you to check that your TV aerial and radio aerial are properly connected.

- > Press GO to start auto tuning. The television tunes in all available programs.

Determine the centre position

If your television is equipped with the optional motorised stand, the **STAND ADJUSTMENT** menu appears on the screen. Once the centre position is determined, select your favourite positions for when the television is switched on and in standby.

When the STAND ADJUSTMENT menu appears ...

- > Press **GO** to start stand adjustment.
- > If the adjustment is interrupted the text 'ADJUSTMENT FAILED' appears on the screen. Remove obstacles preventing the television from turning, and press **GO** to start adjustment again.
- > Once adjustment is complete, the text 'ADJUSTMENT OK' appears, followed by the **STAND POSITIONS** menu.
- > Move between the different stand positions; **VIDEO**, **AUDIO** and **STANDBY** by means of **▲** and **▼** and press **GO** to enter the menu.
- > To turn the television, press **◀** or **▶**.
- > Press the green button to store each of the positions.

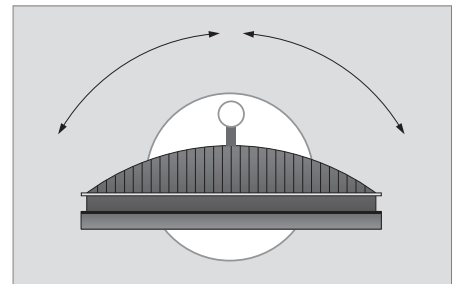
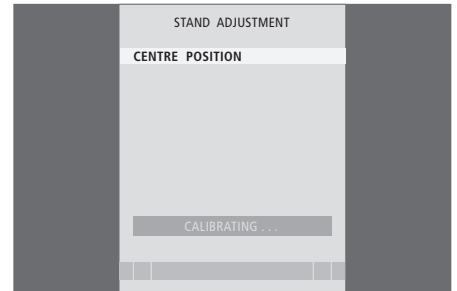

Make sure that there is enough room for the television to turn to the right and left.

For further information about stand positions, refer to the chapter 'Set positions for the television to turn to' on page 28.

Edit tuned programs

You can only store a total of 99 radio programs. If automatic tuning of all radio programs results in more than 99 programs, the EDIT RADIO PROGRAMS menu appears automatically after tuning. You must then move the radio programs you want to a position within 1 and 99 in the list.

You can at any time rearrange the order in which your radio and TV programs appear, just call up the EDIT RADIO PROGRAMS or EDIT TV PROGRAMS menus to do so. These menus also allow you to name and delete radio and TV programs.

If the tuned programs require additional editing, such as fine tuning, use the MANUAL TUNING menu.

Move tuned radio programs

If automatic tuning results in more than 99 programs, the EDIT RADIO PROGRAMS menu appear automatically.

- > Press **▶▶** to start editing your radio programs.
- > Press **▼** or **▲** to select the program you wish to move.
- > Press **▶▶** once move the program out of the list.
- > Press **▼** or **▲** to move the program to the desired program number.
- > Press **◀◀** to make the program move back into the list or change places with the program which occupies the desired program number.
- > Now, move the program which you changed places with to an empty program number or to a number already occupied and repeat the procedure, or if you wish to delete the program, simply press the yellow button when the program is moved out of the list.
- > When you have moved the relevant programs, press **STOP** to back up through all menus, or press **EXIT** to exit all menus.

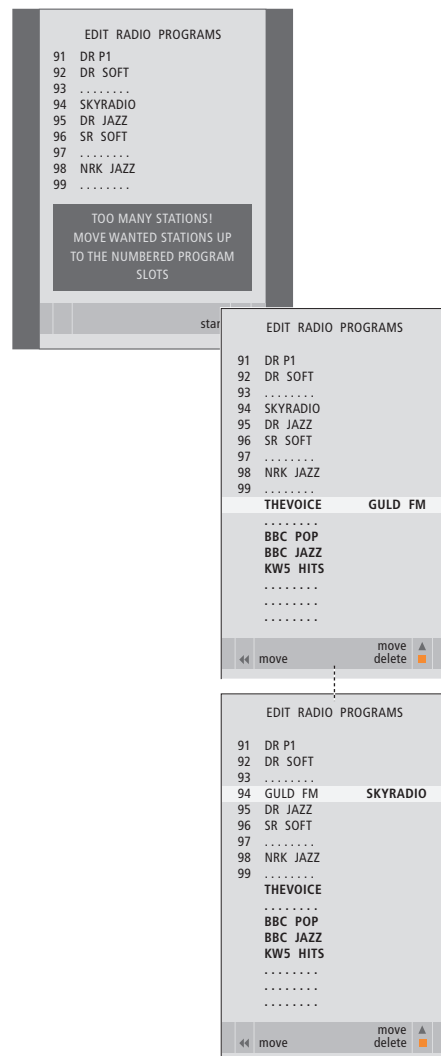

Note that all programs placed on unnumbered program slots are deleted when you exit this menu.

NOTE! The described FM radio functions and DAB radio functions are only available if your television is equipped with the optional FM or FM/DAB module.

Move or delete tuned programs

At any time, you can move or delete any tuned TV or radio programs you do not want.

Move programs ...

- > Press **TV** to switch on the television, or **RADIO** to switch on the radio.
- > Press **MENU** to bring up the SETUP menu, and press **▼** to highlight TUNING.
- > Press **GO** to bring up the TUNING menu. EDIT PROGRAMS is already highlighted.
- > Press **GO** to bring up the EDIT PROGRAMS menu.
- > Press **▼** or **▲** to select the program you wish to move.
- > Press **▶▶** once to be able to move the program. The program is now moved out of the list.
- > Press **▼** or **▲** to move the program to the desired program number.
- > Press **◀◀** to make the program move back into the list or change places with the program which occupies the desired program number.
- > Now, move the program which you changed places with to an empty program number or to a number already occupied and repeat the procedure.
- > When you have moved the relevant programs, press **STOP** to back up through all menus, or press **EXIT** to exit all menus.

Delete programs ...

- > Press **TV** to switch on the television, or **RADIO** to switch on the radio.
- > Press **MENU** to bring up the SETUP menu and press **▼** to highlight TUNING.
- > Press **GO** to bring up the TUNING menu. EDIT PROGRAMS is already highlighted.
- > Press **GO** to bring up the EDIT PROGRAMS menu.
- > Press **▼** or **▲** to move to the program you wish to delete.
- > Press **▶▶** to move the program out of the list.
- > Press the yellow button to be able to delete the program – the program is then shown in red.
- > Press the yellow button again to finally delete the program, or press **◀◀** twice to move the program back into the list.
- > When you have deleted the relevant programs, press **EXIT** to exit all menus.

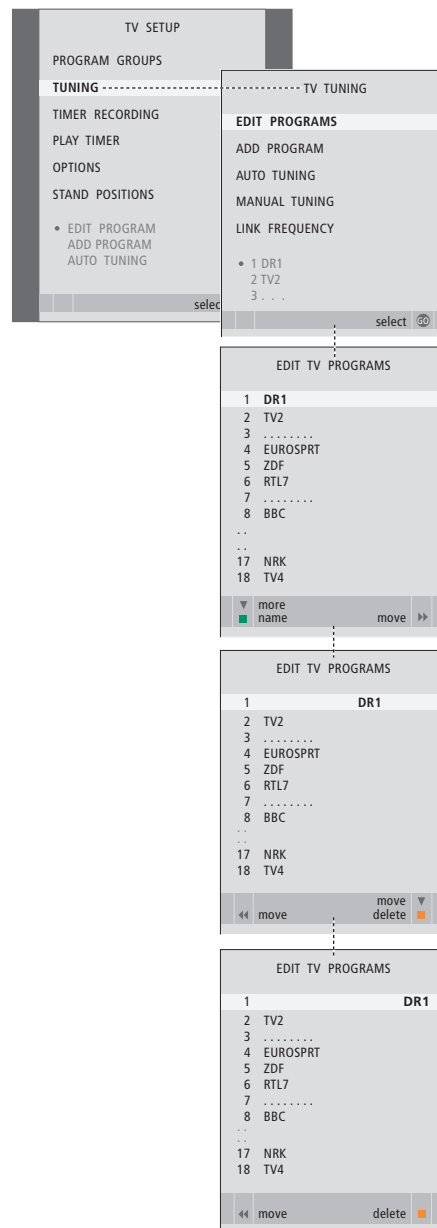

Name tuned programs

The EDIT PROGRAMS menu also allows you to name all programs yourself.

Name programs ...

- > Press **TV** to switch on the television, or **RADIO** to switch on the radio.
- > Press **MENU** to bring up the SETUP menu, and press **▼** to highlight TUNING.
- > Press **GO** to bring up the TUNING menu. EDIT PROGRAMS is already highlighted.
- > Press **GO** to bring up the EDIT PROGRAMS menu.
- > Press **▼** or **▲** to select the program you wish to name.
- > Press the green button to be able to name the program. The naming menu is now activated.
- > Press **▼** or **▲** to find the individual characters in the name.
- > Press **▶▶** to move to the next character. As you move, the television suggests possible names, but you can still use **▲** and **▼**, or **◀◀** and **▶▶** to enter or edit all the characters in the name you choose.
- > Press **GO** to store the name.
- > If necessary, repeat the procedure and name other program numbers.
- > When you have named the relevant programs, press **GO** to accept your edited list, or press **EXIT** to exit all menus.

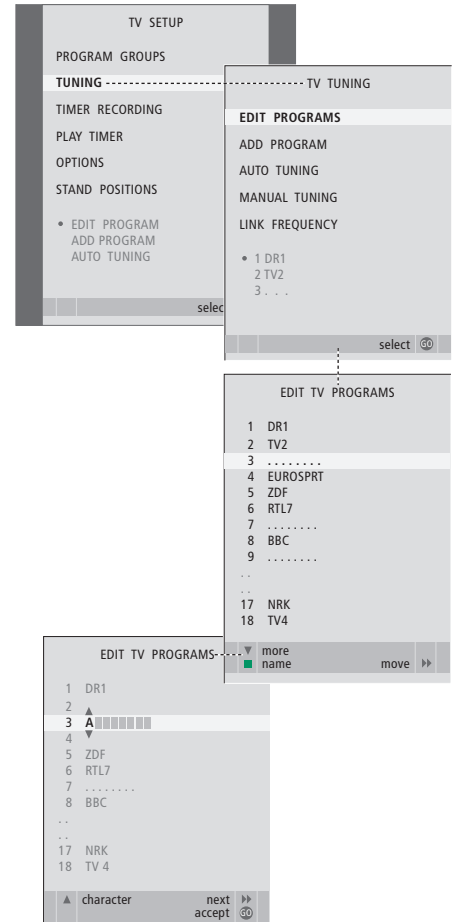

Adjust tuned TV programs – manual tuning

You can store TV programs on program numbers of their own. Fine tune the program reception, indicate the presence of coded programs and choose appropriate sound types for the individual programs.

- > Press **TV** to switch on the television.
- > Press **MENU** to bring up the TV SETUP menu and press **▼** to highlight TUNING.
- > Press **GO** to bring up the TV TUNING menu and press **▼** to highlight MANUAL TUNING.
- > Press **GO** to bring up the TV MANUAL TUNING menu.
- > Press **▼** or **▲** to move between items on the menu.
- > Press **◀** or **▶** to view your choices for each item.
- > If you choose NAME, then press the green button to start the naming procedure. Use **▼** or **▲** and **▶** to enter the characters in the name you choose.
- > To bring up the extra TV MANUAL TUNING menu, move to EXTRA and press **GO**. Now fine tune if relevant, or select type of sound.
- > When you have finished editing, press **GO** to accept the settings.
- > Press **GO** to store the adjusted program.
- > Press **EXIT** to exit all menus.

If the item SYSTEM appears on the menu, then make sure that the correct broadcast system is displayed before you begin tuning:

- B/G ... for PAL/SECAM BG
- I ... for PAL I
- L ... for SECAM L
- M ... for NTSC M
- D/K ... for PAL/SECAM D/K

If programs are broadcasted with two languages and you want both languages, you can store the program twice, once with each language.

Even though you store a type of sound/language, you can switch between the various types while watching a TV programme. For further information, refer to the chapter 'Adjust sound and picture format' on page 8 in the Guide.

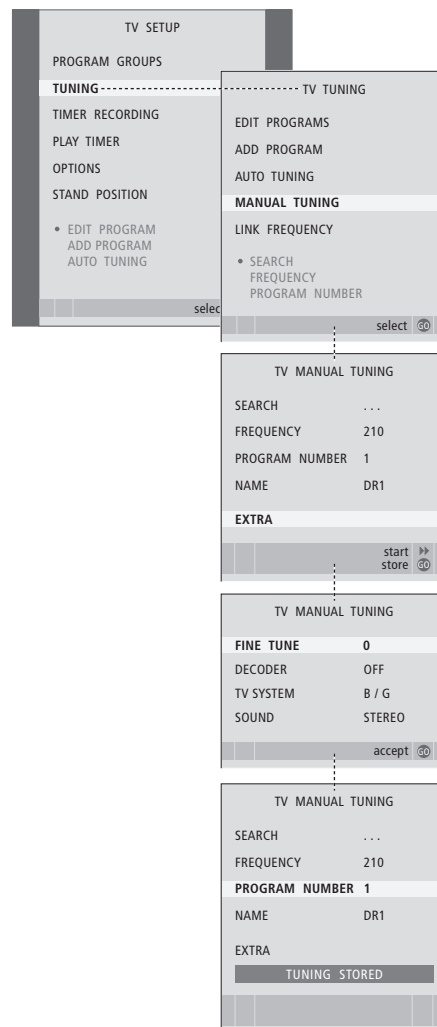

Adjust tuned FM or DAB programs – manual tuning

If your television is equipped with the optional FM or FM/DAB module, you can tune in FM and DAB radio programs. During first time setup both types of radio programs are tuned in.

- > Press **RADIO** to switch on the radio.
- > Press **MENU** to bring up the SETUP menu and press **▼** to highlight TUNING.
- > Press **GO** to bring up the RADIO TUNING menu and press **▼** to highlight MANUAL TUNING.
- > Press **GO** to bring up the RADIO MANUAL TUNING menu.
- > Press **▼** or **▲** to move between items on the menu.
- > Press **◀** or **▶** to view your choices for each item.
- > When you switch between FM and DAB the menu changes appearance.
- > If you choose NAME, then press the green button to start the naming procedure. Use **▼** or **▲** and **▶** to enter the characters in the name you choose.
- > When you have finished editing, press **GO** to accept the settings.
- > Press **GO** to store the adjusted program.
- > Press **EXIT** to exit all menus.

What's on the FM RADIO TUNING menu ...

FM/DAB ... Choose between FM and DAB.
 SEARCH ... Start searching the frequency band up or down.
 FREQUENCY ... Select a frequency to tune in.
 PROGRAM NUMBER ... Store or change program number. You can store a total of 99 radio programs.
 NAME ... Access the naming function and name the program you have selected.
 FINE TUNE ... Fine tune the frequency of a program or tuned program. You can fine tune within the range of -4 – +4.
 SOUND ... Choose between stereo or mono. The receiver will switch automatically to Mono sound if the Stereo signal is affected by noise.

What's on the DAB RADIO TUNING menu ...

FM/DAB ... Choose between FM and DAB.
 SEARCH ... Start searching the frequency band up or down.
 CHANNEL ... Select a channel to tune in. Enter the channel number by means of the number buttons, change between letters by means of the arrow buttons left and right.
 (ENSEMBLE) ... This field informs you of the found ensemble, no selection can be made here.
 PROGRAM ... Choose between different programs within the found 'ensemble'.
 PROGRAM NUMBER ... Store or change program number. You can store a total of 99 radio programs.
 NAME ... Access the naming function and name the program you have selected.

| RADIO MANUAL TUNING | |
|---|-----------|
| FM / DAB | FM |
| SEARCH | 92.6 |
| FREQUENCY | ... |
| PROGRAM NUMBER | 10 |
| NAME | STRUER |
| FINE TUNE | 0 |
| SOUND | STEREO |
| store  | |

| RADIO MANUAL TUNING | |
|---|------------|
| FM / DAB | DAB |
| SEARCH | ... |
| CHANNEL | 12 C |
| DR DAB | |
| PROGRAM | DR SOFT |
| PROGRAM NUMBER | 10 |
| NAME | DR SOFT |
| store  | |

What's on the ADJUST DAB AERIAL menu ...

When an 'ensemble' has been found, this menu can be used to optimise signal reception.

The bar at the top of the menu shows the reception quality.

If no ensembles have been found, you can enter a channel number by means of the number buttons, change between letters by means of the arrow buttons left and right, and then move the DAB aerial until an 'ensemble' name appears in the menu.

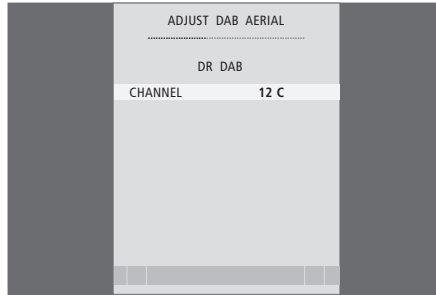

The 'ADJUST DAB AERIAL' menu helps you find the best placement for your dab aerial.

Turn your DAB aerial to a position where the bar is as filled out as possible.

What's on the DYNAMIC RANGE CONTROL menu ...

For certain DAB programs, you can adjust audio signal compression with the DRC (Dynamic Range Control) function. Compression compensates for sources of noise in your immediate surroundings. There are twelve possible settings, with three values to guide you:

- OFF (no compression)
- MIDDLE (recommended by the DAB provider)
- MAX (maximum compression, twice that recommended by the DAB provider).

DAB DRC menu settings have no effect for programs not broadcast with DRC.

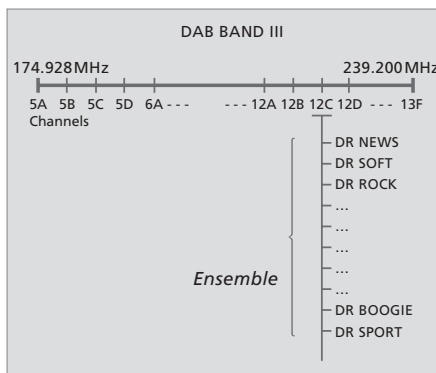
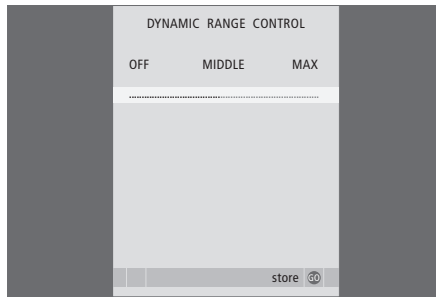

Digital Audio Broadcast (DAB) providers broadcast programs in groups called ensembles. A channel contains a single ensemble, and an ensemble typically contains 5–10 programs. Some DAB providers call an ensemble a 'multiplex', or call a program a 'service'.

Re-tune or add programs

You can make your television find your TV and radio programs for you.

Preset up to 99 different TV and radio programs on program numbers of their own and give each program a distinct name.

You can tune in new programs, for example, if you move – or re-tune previously deleted programs.

When tuning in programs via the ADD PROGRAM menu, your previously tuned programs are left unchanged. This allows you to keep program names, their order in the TV or radio lists, and any special settings you may have stored for those programs, such as decoder or broadcast system settings.

Re-tune via automatic tuning

You can re-tune all your TV and radio programs by letting the television tune in all the programs automatically.

- > Press **TV** to switch on the television, or **RADIO** to switch on the radio.
- > Press **MENU** to bring up the SETUP menu and press **▼** to highlight TUNING.
- > Press **GO** to bring up the TUNING menu and press **▼** to highlight AUTO TUNING.
- > Press **GO** to bring up the AUTO TUNING menu.
- > Press **▶▶** to start auto tuning.
- > Once auto tuning is completed, the EDIT PROGRAMS menu appears. You can then rearrange the program order, delete programs or rename them.

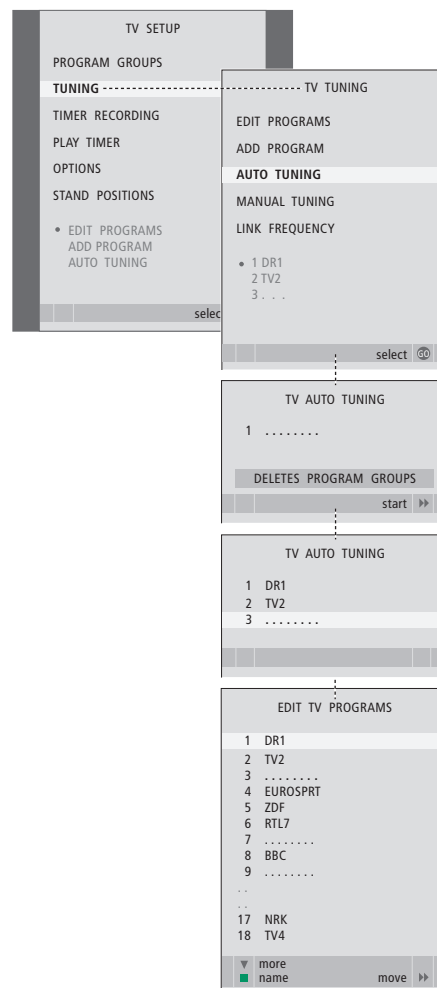

Please note: If you re-tune all your TV and radio programs, all Groups of programs and program settings, you have made, disappear!

Add new programs

You can add a new program or update a tuned program which, for example, has been moved by the broadcaster.

- > Press **TV** to switch on the television, or **RADIO** to switch on the radio.
- > Press **MENU** to bring up the SETUP menu and press **▼** to highlight TUNING.
- > Press **GO** to bring up the TUNING menu and press **▼** to highlight ADD PROGRAM.
- > Press **GO** to bring up the ADD PROGRAM menu.
- > Press **▶▶** to start. New programs are added automatically as they are found.
- > When tuning is completed and new programs have been added, the EDIT PROGRAMS menu appears. You can then rearrange the program order, delete programs or rename them. The cursor highlights the first new program of those just added to the list.

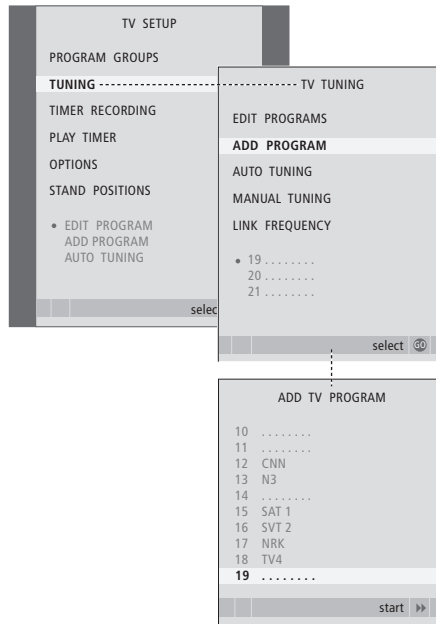

Set positions for the television to turn to

If your television is equipped with the optional motorised stand, you can turn it using the Beo4 remote control.

Furthermore, you can program the television to turn automatically to face your favourite viewing position when you switch on the television, turn to a different position when you listen to radio, and turn away to a standby position when you switch it off.

You can also turn your television by hand.

Choose one position for when you switch the television on, one for radio and one for when you switch it off.

- > Press **TV** to switch on the television.
- > Press **MENU** to bring up the TV SETUP menu and press **▼** to highlight STAND POSITIONS.
- > Press **GO** to bring up the STAND POSITIONS menu.
- > Press **GO** to determine the VIDEO position.
- > Press **◀** or **▶** to turn the television, and place it according to your viewing position.
- > Press **GO** to store the position.

To store a stand position for when the radio is switched on ...

- > Press **▼** to move to AUDIO.
- > Press **GO** to determine the AUDIO position.
- > Press **◀** or **▶** to turn the television, and place it as you wish.
- > Press **GO** to store the position.

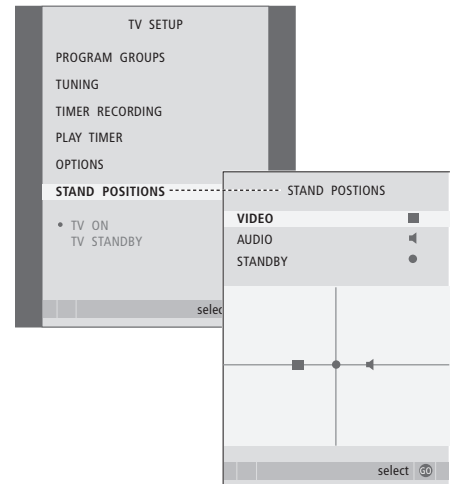

To store a stand position for when the television is switched off and in standby ...

- > Press **▼** to move to STANDBY.
- > Press **GO** to determine the STANDBY position.
- > Press **◀** or **▶** to turn the television, and place it as you wish.
- > Press **GO** to store the position.
- > Press **EXIT** to leave the menus.

NOTE! For information about first-time installation of the motorised stand, refer to the chapter 'First-time setup of your television' on page 16.

Set the time and date

When you preset your television to switch itself on or off at a particular time, or when you preset a timed recording of a programme on a connected video recorder, the clock ensures that these features are switched on and off at the right times.

The simplest way to set the clock is to synchronise it with a tuned TV program's teletext service via the CLOCK menu. If you choose to synchronise the clock, this is done with the teletext service offered by the TV program you are currently watching. If a teletext service is not available, you can set the clock manually.

To bring up the clock in the display, press LIST repeatedly to display CLOCK on Beo4, then press GO. To remove the clock again, repeat the procedure.*

Before synchronising the clock with a tuned program, make sure that the program you are watching offers a teletext service.

- > Press TV to switch on the television.
- > Press MENU to bring up the TV SETUP menu and press ▼ to highlight OPTIONS.
- > Press GO to bring up the OPTIONS menu and press ▼ to highlight CLOCK.
- > Press GO to bring up the CLOCK menu.
- > Press ◀ or ▶ to see your choices for each item.
- > Press ▲ or ▼ to move through menu items. It is only necessary to enter the time manually if SYNCHRONISE is set to NO.
- > Press GO to store your clock and calendar options, or ...
- > ... press EXIT to exit all menus without storing.

If the clock is not updated in the transition between summer and winter time, simply select the program with which you originally synchronised the clock, and the clock is updated.

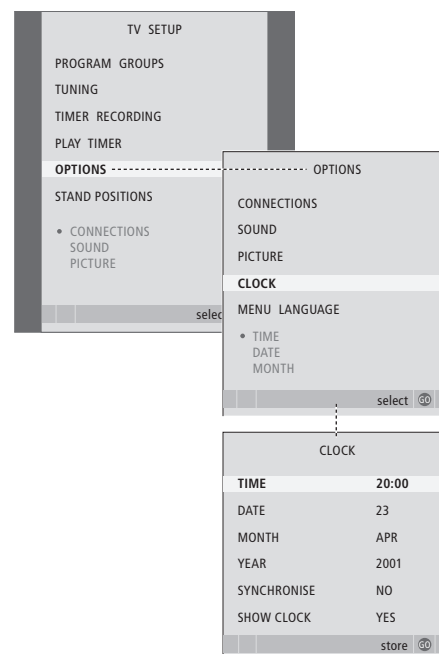

Abbreviations for months

| | | | |
|---------|----------|---------|-----------|
| Jan ... | January | Jul ... | July |
| Feb ... | February | Aug ... | August |
| Mar ... | March | Sep ... | September |
| Apr ... | April | Oct ... | October |
| May ... | May | Nov ... | November |
| Jun ... | June | Dec ... | December |

*NOTE! In order to display CLOCK on Beo4, you must first add it to the Beo4 list of functions. For further information, refer to the chapter 'Customise Beo4' on page 66.

Adjust picture and sound settings

Picture and sound settings are preset from the factory to neutral values which suit most viewing and listening situations. However, if you wish, you can adjust these settings to your liking.

Adjust picture brightness, colour or contrast. Sound settings include volume, bass and treble.

Store your picture and sound settings temporarily – until your television is switched off – or store them permanently.

For information about how to change the picture format, refer to the Guide page 9.

Change brightness, colour or contrast

Adjust the picture settings via the PICTURE menu. Temporary settings are cancelled when you switch off the television.

- > Press **TV** to switch on the television.
- > Press **MENU** to bring up the TV SETUP menu and press ▼ to highlight OPTIONS.
- > Press **GO** to bring up the OPTIONS menu and press ▼ to highlight PICTURE.
- > Press **GO** to bring up the PICTURE menu.
- > Press ▲ or ▼ to move through menu items.
- > Press ◀ or ▶ to adjust the values.
- > Press **EXIT** to store your settings until you switch off the television, or ...
- > ... press **GO** to store your settings permanently.

To temporarily remove the picture from the screen, press LIST repeatedly to display P.MUTE on Beo4, then press GO. To restore the picture again, press any source button, such as TV.

What's on the PICTURE menu ...

BRIGHTNESS ... Adjusts the picture brightness.

CONTRAST ... Adjusts the contrast level in the picture.

COLOUR ... Adjusts the colour intensity in the picture.

For video sources using the NTSC signal, a fourth option – Tint (colour shade or nuance) – will be available for adjustment.

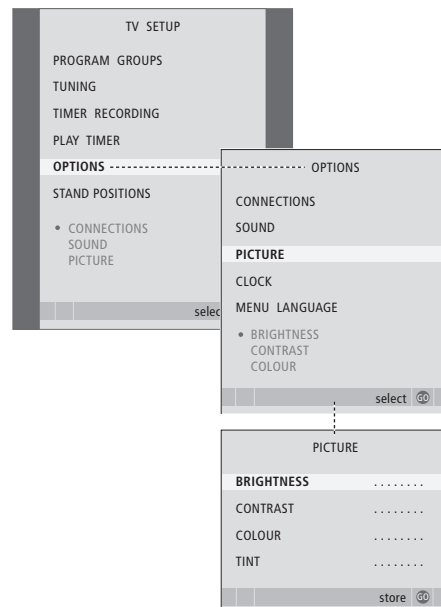

Change volume, bass or treble

Adjust the sound settings via the SOUND SETUP menu. Temporary settings are cancelled when you switch off the television.

- > Press **TV** to switch on the television.
- > Press **MENU** to bring up the TV SETUP menu and press **▼** to highlight **OPTIONS**.
- > Press **GO** to bring up the OPTIONS menu and press **▼** to highlight **SOUND**.
- > Press **GO** to bring up the SOUND menu.
- > Press **▲** or **▼** to move through menu items.
- > Press **◀** or **▶** to adjust the values or choose a setting.
- > Press **EXIT** to store your settings until you switch off the television, or ...
- > ... press **GO** to store your settings permanently.

If you connect loudspeakers or headphones ...

The content of the SOUND menu varies according to what you have connected to the television.

What's on the SOUND SETUP/SOUND ADJUSTMENT menu ...

- VOLUME** ... Adjusts the volume level the TV uses when you switch it on.
- (CENTRE)** ... Only available if you have connected loudspeakers to the television. Adjusts the balance between the external and internal speakers.
- (BALANCE)** ... Adjusts the balance between the speakers.
- BASS** ... Adjusts the bass level.
- TREBLE** ... Adjusts the treble level.
- LOUDNESS** ... The loudness feature compensates for the human ear's lack of sensitivity to high and low frequencies. These frequencies are boosted at low volume levels so that low music becomes more dynamic. Loudness can be set to ON or OFF.

The contents of this menu varies according to your speaker setup.

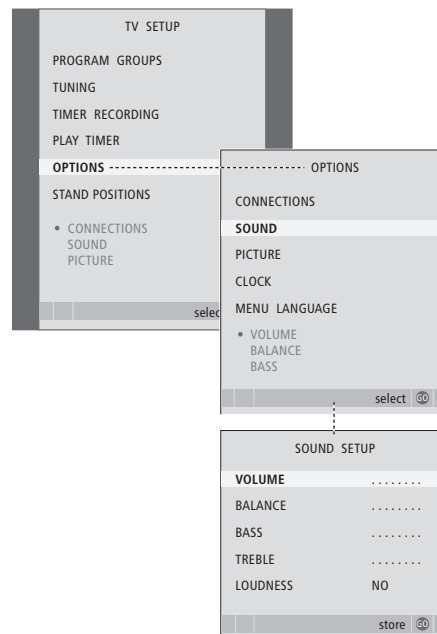

Choose menu language

The menu language you choose during the first-time setup of your television can be changed at any time.

Once a menu language is chosen, all menus and display messages are shown in this language.

You can select the language for on-screen menus via the TV SETUP menu. The text on the screen changes as you move from language to language.

- > Press **TV** to switch on the television.
- > Press **MENU** to bring up the TV SETUP menu and press **▼** to highlight **OPTIONS**.
- > Press **GO** to bring up the **OPTIONS** menu and press **▼** to highlight **MENU LANGUAGE**.
- > Press **GO** to bring up the **MENU LANGUAGE** menu.
- > Use **▼** and **▲** to move to your language choice.
- > Press **GO** to make your choice.
- > Press **STOP** to back up through previous menus or press **EXIT** to exit all menus directly.

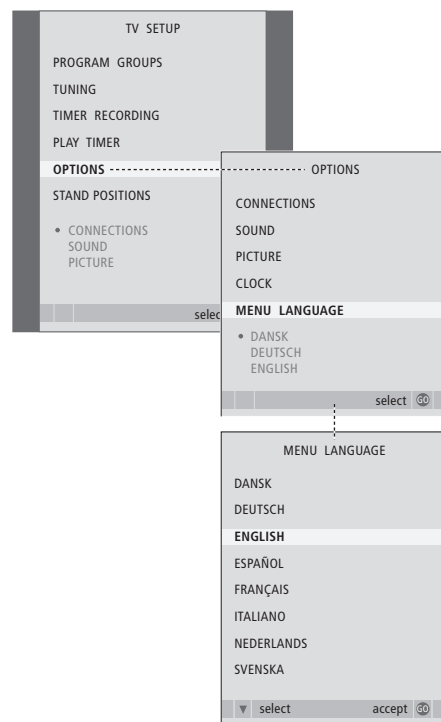

You can change the radio display at any time. Your choice determines what is shown on the screen, when you select radio as your source.

When you change the radio display style in the RADIO DISPLAY menu, a sample of the display style is shown in the menu.

- > Press **RADIO** to switch on the radio.
- > Press **MENU** to bring up the RADIO SETUP menu and press **▼** to highlight TUNING.
- > Press **GO** to bring up the RADIO TUNING menu and press **▼** to highlight RADIO DISPLAY.
- > Press **GO** to bring up the RADIO display menu.
- > Press **◀** or **▶** to change the settings.
- > Press **GO** to store your choice.
- > Press **STOP** to back up through previous menus or press **EXIT** to exit all menus directly.

What's on the RADIO DISPLAY menu ...

STYLE ... Select the display settings for when you listen to radio. Options are:

MAXIMUM ... Shows text sent out by the broadcaster continuously, as well as radio program number, name of the radio program, frequency or 'ensemble' name.

TIME OUT ... Shows the maximum display but removing the display when the text sent out by the broadcaster has been shown once*.

MINIMUM ... Shows the radio program number and the name of the radio program.

OFF ... No display in radio mode.

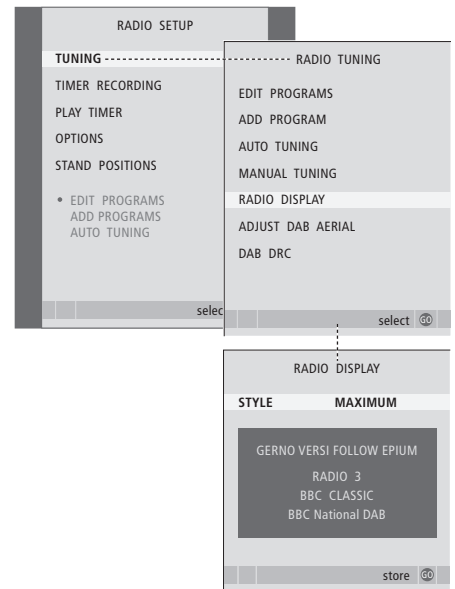

*NOTE! If you have chosen the radio display style 'TIME OUT', you can bring up the radio display briefly on the screen by pressing GO,

In this chapter, you can find out how to place and connect your television. It also gives you an overview of the socket panels.

We recommend that you follow the procedure described below when you set up your television:

- Unpack the television
- Consider the appropriate surroundings for your television
- Mount the television on the chosen stand or bracket
- Place the television
- Connect the cables, additional equipment, and speakers

This procedure is described in detail on the following pages.

Advanced operation, 5

All you need to know about using your television beyond daily use, such as how to operate timed play and timed standby functions, and a connected set-top box. How to operate a surround sound system.

Tuning and preference settings, 15

Find out how to set up your television for the first time and tune in programs. This chapter also contains information about settings for time, date, stand positions, picture and sound.

Placement, sockets and connections, 35

- Set up your television, 36
- Camera and headphones sockets, 39
- Socket panel, 40
- Connect additional video equipment, 42
- Register additional video equipment, 46
- Loudspeaker setup – surround sound, 48

BeoLink system, 55

Find out how to connect an audio system to your television and operate an integrated audio/video system. Find out how to make link connections, operate a link system and set up your television in a link room. How to customise Beo4 to your system.

Index, 68

Set up your television

For information about how to fasten and run the cables on the rear of the television, refer to page 38.

For further information about the socket panel, refer to page 40.

Handling your television

- Avoid placing your television in direct sunlight or direct artificial light, such as a spotlight, as this may reduce the sensitivity of the remote control receiver. Also if the screen is overheated, black spots may appear in the picture. These spots disappear again, once the television cools down to normal temperature.
- To avoid injury, use Bang & Olufsen stands or brackets only.
- Make sure that the television is set up, placed and connected in accordance with these instructions.
- The television is developed for indoor use in dry, domestic environments only. Use within a temperature range of 10–40°C (50–105°F).
- Do not place any items on top of the television.
- Always place your television on a firm and stable surface.
- Do not attempt to open the television. Leave such operations to qualified service personnel.

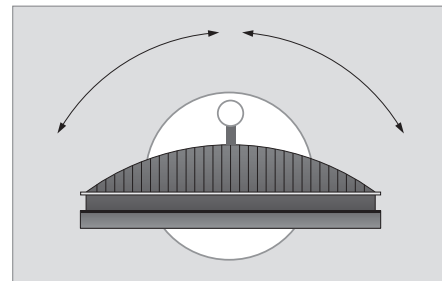

If you have a motorised stand, leave enough space around the television to allow it to turn freely. The television can also be turned by hand.

Overview of socket panels

- 1 Cover for fastening bracket for the optional stand and wall bracket. Pull out at the bottom to remove the cover.
- 2 Main socket panel. Refer to page 40 for further information.
- 3 Cover for DVI socket for connection of a computer. Refer to page 41 for further information.
- 4 Cover for main socket panel. Pull out at the bottom to remove the cover.
- 5 Cover for optional card reader for access to DVB programs.
- 6 Cover for camera and headphones sockets. Push in to open, push again to close.
- 7 Cable groove. It is important that the cables are lead through the groove and tied with a cable tier, as the cables can otherwise be tugged free of the sockets. Refer to page 38 for further information.

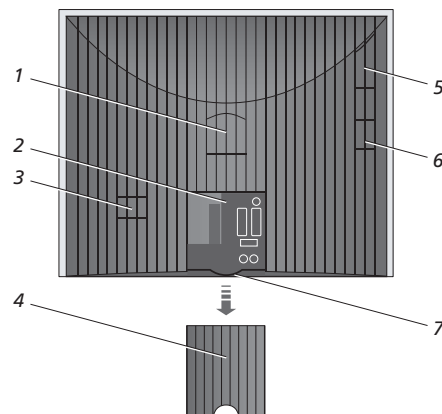

Placement options

The television can be placed in several ways, some are illustrated to the right. Please contact a Bang & Olufsen retailer for further information.

If you mount the television on one of the motorised stands or on the wall bracket, you can tilt the television up and down, as well as turn it left and right. Note, however, that tilting can only be done manually.

While mounting the television on the base, stand or wall bracket, you can use the packaging to support the products. This makes mounting easier. For further information, refer to the Guide enclosed with these accessories.

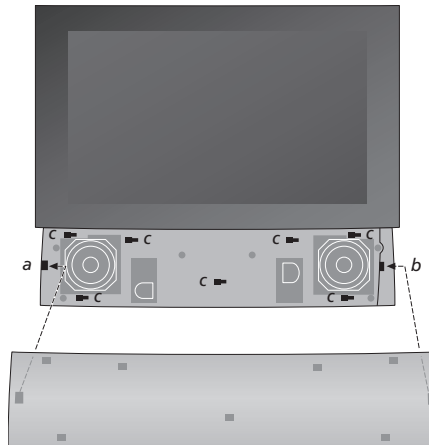
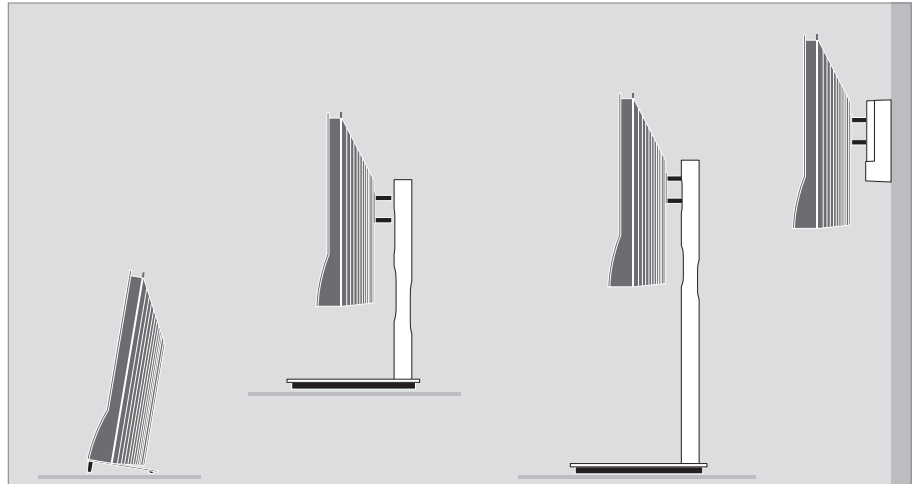

Attaching the speaker cover: Hold up the speaker cover slightly to the right of the 'brackets' a and b. Now slide the cover to the left to let the 'attach-points' engage with the corresponding 'brackets' (a, b and c) on the television.

To remove the cover; use your thumb to push the cover to the right to disengage it, then lift it out.

Aerial and mains connections

When you set the television up on its own, simply connect the TV aerial to the TV socket and a FM aerial to the socket marked FM and connect the television to the mains as shown to the right.

If your television is equipped with the optional DAB module, you must connect a DAB aerial also.

When using a DAB aerial ...

- Use the DAB AERIAL ADJUSTMENT menu, described on page 23, to find out where to place your aerial. The menu lets you know how strong the DAB signal is.
- Make sure that you hang or mount the aerial vertically.

If you are going to connect speakers, an audio system or any other equipment to the television, do not connect it to the mains yet!

The supplied mains cord and plug are specially designed for the television. If you change the plug or in any way damage the mains cord, it will affect the TV picture adversely!

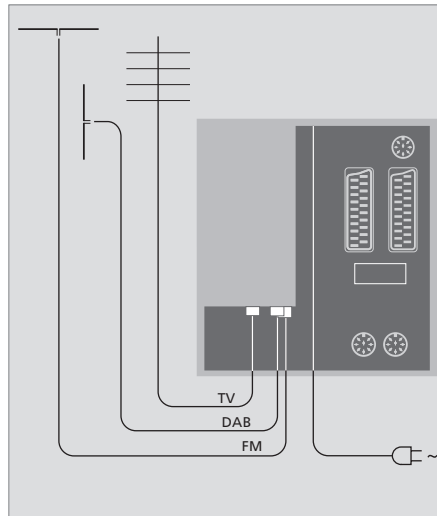

When connections are complete and the cables have been secured as described on this page, switch on the mains. A tiny, red light appears below the screen. The system is in standby mode and ready to be used. If your television is set up on its own, you can now tune in programs as explained in the chapter 'First-time setup of your television' on page 16.

Your television was designed to be left in standby mode when not in use. Therefore, to facilitate remote control operation, it is essential that you do not disconnect it from the mains. The television can only be switched off completely, if you disconnect it from the mains.

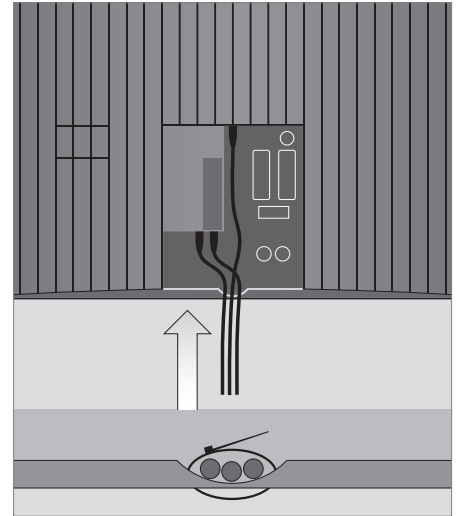

IMPORTANT! All the cables must be fastened to the television using the enclosed cable tier as shown.

When you have made all the connections and fastened the cables, mount the cable cover again.

You can connect headphones and listen to a programme, or you can connect a Camcorder and watch your home movies on the television. If you have connected a BeoCord V 8000 video tape recorder, you can copy Camcorder recordings onto a videotape.

Sockets for temporary connections

PHONES

You can connect stereo headphones to the socket marked PHONES. The television speakers are muted when headphones are connected and activated again when the headphones are disconnected.

These sockets are for the connection of a Camcorder:

VIDEO

For the video signal.

R – L

For audio connection (right and left sound channel respectively).

Watch digital pictures on your television

To watch your camera pictures, connect the camera and switch the television on. The television automatically registers the signal and you can see the still pictures on the screen.

If the signal from the camera is switched off ...

> Press LIST repeatedly to display CAMERA on Beo4 and press GO.

In order to display CAMERA on Beo4, you must first add it to the Beo4 list of functions. For further information, refer to the chapter 'Customise Beo4' on page 66.

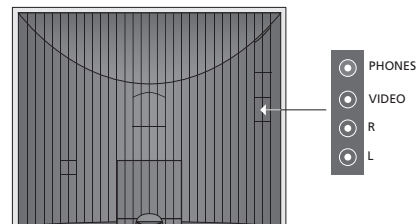

Watch and copy from a Camcorder

If you have connected a video tape recorder, such as a BeoCord V 8000, to your television, and you connect your Camcorder, you can copy Camcorder recordings onto a videotape.

To copy a recording from a Camcorder ...

- > Connect your Camcorder and start playback on the Camcorder. The television automatically registers the signal and you can see the pictures on the television screen.
- > Press RECORD twice to start recording.

Choosing another source or switching off the television during recording from a Camcorder disrupts recording. It is not possible to view TV programs during recording.

Socket panel

The socket panel on your television allow you to connect signal input cables as well as a variety of extra equipment, such as a video recorder or a linked Bang & Olufsen music system.

The AV sockets are the primary sockets for connection of extra equipment. Any equipment you connect to these sockets must be registered in the CONNECTIONS menu. For further information, refer to the chapter *'First-time setup of your television'* on page 16.

You can also connect a computer and use your television as a monitor.

Sockets on the rear panel

AV3

L
Left, line signal (for sound from PC).

R
Right, line signal (for sound from PC).

Y – Pb – Pr

For connection of external equipment.

LINK

Aerial output socket for distribution of video signals to other rooms. Requires an RF Link Amplifier also.

DVB DATA

For service use.

~

Connections to the mains.

DAB

Aerial input socket for DAB aerial. Only available if your television is equipped with the optional FM/DAB module.

TV

Aerial input socket from your external aerial or cable TV network, or from your main room television if this television is placed in a link room.

FM/DVB

Aerial input socket from your FM or DVB aerial. Only available if your television is equipped with the optional FM module or DVB module.

STAND

For connection of a motorised stand.

AV2 (AV)

21-pin socket for the AV connection of other equipment, such as a DVD player, a set-top box, a second decoder or a game console. The socket may be used for an AV 2 Expander instead, which gives the opportunity to connect other non-Bang & Olufsen video equipment at the same time.

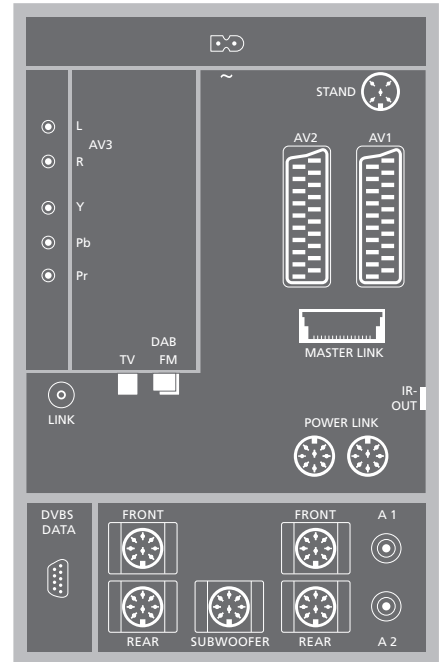

AV1 (AV VMEM)

21-pin socket for the connection of a Bang & Olufsen video recorder, a set-top box, a decoder or another video tape recorder. You can also connect other types of extra equipment.

MASTER LINK

Socket for connection of a compatible Bang & Olufsen music system. The socket is also used for BeoLink distribution of sound throughout the house.

POWER LINK

For connection of external Bang & Olufsen loudspeakers.

IR out

For a connected set-top box.

The speaker and digital sockets mentioned below are only available, if your television is equipped with the optional Surround Sound module:

REAR

The two sockets are used for connecting the external rear speakers in a surround sound setup.

FRONT

The two sockets are used for connecting the external front speakers in a surround sound setup.

SUBWOOFER

Socket used for connecting a BeoLab 2 subwoofer in a surround sound setup.

A1 – A2

For digital sound input from external equipment connected to an AV socket group.

Computer connection – DVI socket

Disconnect the television, the computer, and all equipment connected to the computer from the mains.

Using the appropriate type of cable, connect one end to the DVI or VGA output socket on your computer, and the other end to the DVI socket on the television.

To hear sound from the computer in the television speakers, use the appropriate cable and connect the sound output on the computer to the L – R sockets on the television.

Reconnect the television, the computer, and all equipment connected to the computer to the mains.



DVI

DVI connection for receiving digital or analogue graphics from an external PC. Supports the following resolutions: 60 Hz; 640 × 480, 800 × 600, 848 × 480, 1024 × 576, 1024 × 768, 1280 × 720, 1360 × 768.

IMPORTANT! *If you wish to connect a computer to the television and use the television as a monitor, make sure that the television, the computer, and all equipment connected to the computer are all disconnected from the mains before you connect the computer and the television to each other.*

In addition, the computer must be connected to a grounded wall outlet as specified in the computer's setting-up instructions.

If you have connected HD equipment to your television, some video functions are affected:

- The Set-top Box Controller menu described on page 8 does not appear;
- If you have selected FORMAT 2 for letter-box pictures as described on page 11 in the Guide, you cannot scroll the picture up or down;
- You cannot distribute sound or picture from a HD source to a product in a link room;
- You cannot record an HD source, unless your HD equipment also provides a Standard Definition (SD) signal;

Connect additional video equipment

This chapter describes how to connect additional video equipment to the television.

A decoder can be connected to the television via the AV2 socket. If your setup also includes a Bang & Olufsen video recorder, you should connect the decoder to the video recorder.

A set-top box can be connected to any of the AV sockets.

When you connect a Bang & Olufsen video recorder, you must connect it to the AV1 socket, the television detects the connection automatically.

Make sure that all connected equipment is registered in the CONNECTIONS menu. For further information, refer to the chapter 'Register additional video equipment' on page 46.

Connect a decoder

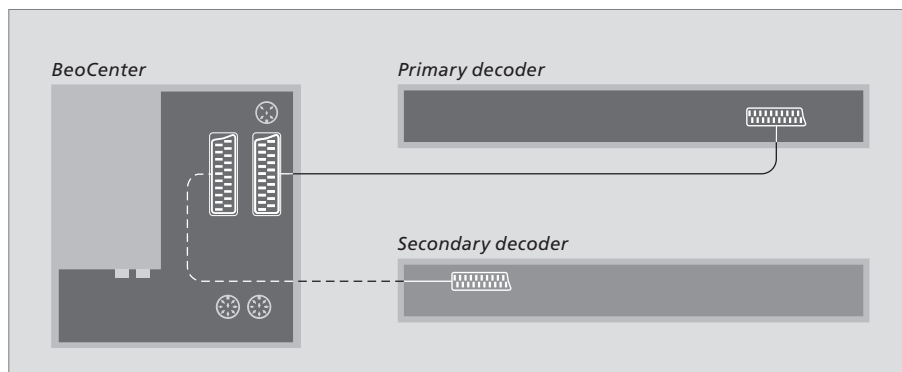

Disconnect all involved systems from the mains before you connect external equipment.

- > Connect the cable from the external aerial to the socket marked TV on the television.
- > Connect the decoder to the 21-pin AV1 socket on the television's socket panel.

If you wish to connect an RF decoder, connect the external aerial cable to the decoder input socket and then forward the signal or cable to the television's aerial socket (marked 'TV IN').

Tuned programs and decoder detection

In most cases, a connected decoder is registered automatically during tuning. The decoder should automatically detect those programs which require decoding. However, if this is not the case, then adjust the setting via the MANUAL TUNING menu for the program in question. Please refer to the section entitled 'Adjust tuned TV programs' in the chapter 'Edit tuned programs' on page 23.

Connect a set-top box

Disconnect all involved systems from the mains before you connect external equipment.

- > Connect one end of a 21-pin AV cable to the set-top box.
- > Run the cable to the AV1 or AV2 socket on the back of the television.
- > Connect the IR transmitter to the IR OUTPUT socket on the television.
- > If your set-top box delivers HDTV video signal, and your television is HD-ready, connect the set-top box to either the DVI-I or Y-Pb-Pr sockets also.
- > Fasten the IR transmitter to the IR receiver of the set-top box.

To be able to use the remote control included with your set-top box, do not cover its IR receiver entirely.

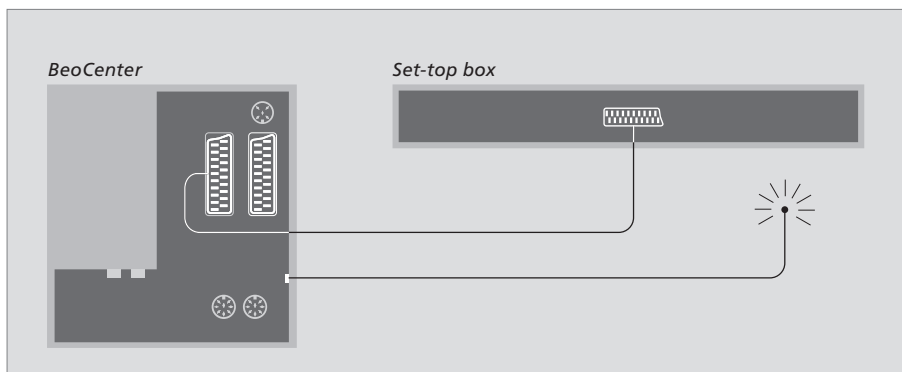

Automatic standby ...

When you register a set-top box in the CONNECTIONS menu, you can also select an 'AUTO STANDBY' time for your set-top box. This means that you can select if the connected set-top box should switch to standby automatically.

The options are:

- AFTER 0 MIN ... The set-top box switches to standby immediately when you select another source.
- AFTER 30 MIN ... The set-top box switches to standby 30 minutes after you have selected another source*.
- AT TV STANDBY ... The set-top box switches to standby when you switch the television to standby.
- NEVER ... The set-top box does not switch to standby automatically.
- FOLLOW TV ... The set-top box switches on, when you switch your television on and it switches to standby, when you switch your television to standby.

Set-top boxes must be set up in accordance with the documentation enclosed with them.

**If you switch the television to standby before the 30 minutes have passed, the set-top box is also switched to standby.*

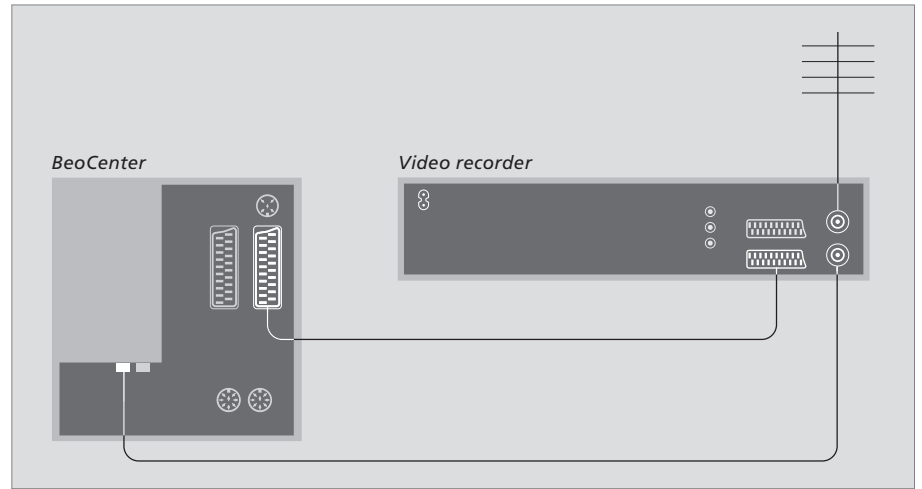
Connect a Bang & Olufsen recorder

Disconnect all involved systems from the mains before you connect external equipment.

- > Connect one end of a 21-pin AV cable to the AV socket on the rear of the recorder.
- > Then run the cable to the AV 1 socket on the back of the television.

Aerial connection

Use your external aerial connection (or cable TV network connection) and the aerial cable supplied with the video recorder.

- > Connect the cable from your external aerial to the signal input socket marked  on the rear panel of the recorder.
- > Direct the aerial signal to the television, using the aerial cable supplied with the recorder.
- > Plug one end into the socket marked 'TV' on the recorder and the other end into the aerial socket marked 'TV' on the television's socket panel.

BeoCord V 8000

If you connect a BeoCord V 8000 to your television, some of the features of the BeoCord V 8000 function differently than described in the BeoCord V 8000 Guide, and some are not available. A supplement for the BeoCord V 8000 Guide is available from your Bang & Olufsen retailer.

Register additional video equipment

If you connect additional video equipment to your television, you must register the equipment in the CONNECTIONS menu.

When the system is first set up, the equipment connected at that particular moment is detected by the television, and the CONNECTIONS menu appears automatically on the screen. If you connect equipment at a later date, on a permanent basis, then you must register this equipment in the CONNECTIONS menu.

For information about where and how to connect extra equipment, refer to the previous pages and the chapter 'Socket panel' on page 40.

What is connected?

Registering the equipment connected to the television enables you to activate it with the Beo4 remote control.

- > Press **TV** to switch on the television.
- > Press **MENU** to bring up the TV SETUP menu and press **▼** to highlight OPTIONS.
- > Press **GO** to bring up the OPTIONS menu. CONNECTIONS is highlighted already.
- > Press **GO** to call up the CONNECTIONS menu.
- > Press **▲** or **▼** to step between the different sockets: AV1, AV2 and AV3.
- > Press **GO** to be able to register a connected product to the highlighted socket.
- > Press **▲** or **▼** to move between the types of sockets.
- > Press **◀** or **▶** to register what you have connected to the highlighted socket.
- > Press **GO** to be able to select another AV socket.
- > When you have completed your settings, press **STOP** to back up through previous menus or press **EXIT** to exit all menus directly.

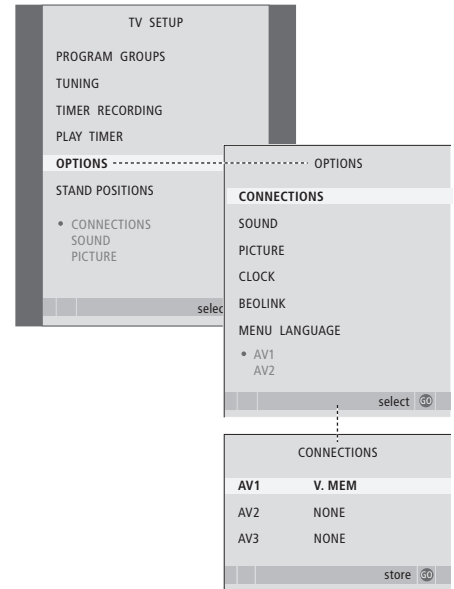

If, for some reason, you disconnect the extra equipment and then disconnect the television from the mains, you may have to register the equipment again upon reconnection, even if you have not changed your setup of extra equipment.

When you have connected additional video equipment to your television, you must also 'tell' the system if you have made additional connections, such as connecting a digital sound input, a digital video signal or an IR transmitter.

What's on the CONNECTIONS menu ...

AV 1

NONE ... if no equipment is connected.

V.MEM ... if you have connected a Bang & Olufsen video recorder or any other video recorder.

V.MEM+DECODER ... if you have connected a Bang & Olufsen video recorder with a decoder connected to it.

V.MEM+STB ... if you have connected a Bang & Olufsen video recorder with a set-top box connected to it.

DECODER ... if you have connected a decoder.

V.AUX ... if you have connected any other type of auxiliary equipment.

STB ... if you have connected a set-top box.

HDTV ... if the source connected to this AV socket delivers HDTV, select which socket is used for HDTV; Options are: YPbPr, DVI or NO.

If you connect a Bang & Olufsen video recorder, the only options for AV 1 are: V.MEM, V.MEM+STB and V.MEM+DECODER.

AV 2

NONE ... if no equipment is connected.

EXPANDER ... if you have connected an Expander box with other auxiliary equipment connected to it.

V.AUX ... if you have connected any other type of auxiliary equipment.

DVD ... if you have connected a DVD player or similar devices.

STB ... if you have connected a set-top box.

HDTV ... if the source connected to this AV socket delivers HDTV, select which socket is used for HDTV; Options are: YPbPr, DVI or NO.

AV 3

NONE ... if no equipment is connected.

PC ... if you have connected a PC.

STB ... if you have connected a set-top box.

HDTV* ... if you have connected audio sound to one of the audio sockets; Options are A1 or A2.

** This option is only available if your television is equipped with the optional surround sound module.*

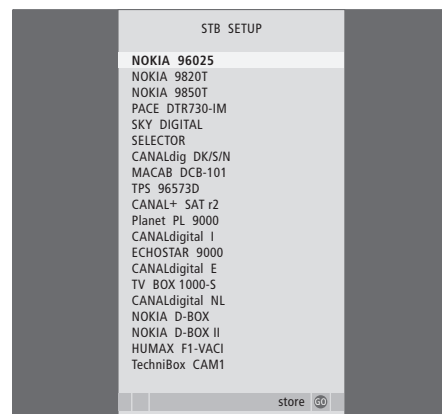

If you have connected a set-top box, you will be prompted to select your set-top box from an on-screen list when you select STB in the CONNECTIONS menu.

Loudspeaker setup – surround sound

If your television is equipped with the optional surround sound module, you can create a surround sound setup.

A surround sound setup fits easily into your living room. Let the picture determine your ideal listening and viewing position. You get the best sound experience in the area created by the speakers.

This chapter explains how to set up speakers for surround sound, as well as how to make the adjustments necessary to get the best sound.

Place external speakers

The three illustrations to the right show examples of how you can place the television and speakers.

The following guidelines apply for all speaker setups:

- If you have two different sets of speakers, always use your most powerful speakers as front speakers.
- Place your speakers where you want them before you connect them.
- Place your rear speakers on either side behind your favourite listening position.
- You do not necessarily have to place the speakers in the corners of the room.
- If you want to connect a BeoLab 2 subwoofer, refer to the subwoofer's own Guide.

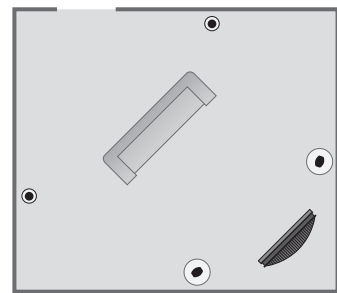
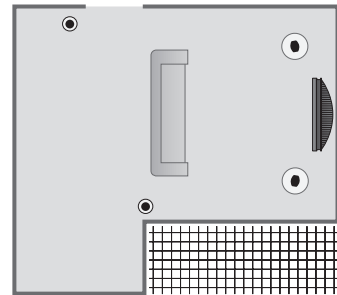
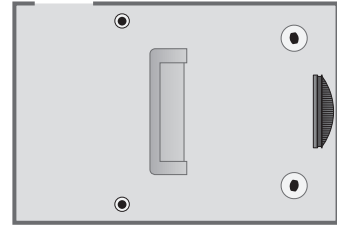

Connect speakers

Connect Bang & Olufsen speakers and a BeoLab 2 subwoofer to the connection panel at the back of the television. The speakers must be Bang & Olufsen Power Link speakers.

To connect speakers...

- > Use the cables enclosed with the speakers.
- > Connect the two front speakers to the sockets marked FRONT.
- > Connect the two rear speakers to the sockets marked REAR.
- > Connect the subwoofer to the socket marked SUBWOOFER.

You can loop the signals from speaker to speaker (as described in the Guide enclosed with your speakers), or you can connect each speaker to a socket. Longer cables and adaptors are available from your Bang & Olufsen retailer.

Remember to set the L–R–LINE switch on both the front and rear set of speakers to L or R (left and right channel) to indicate their position in each set. Set the left speakers to L and the right speakers to R.

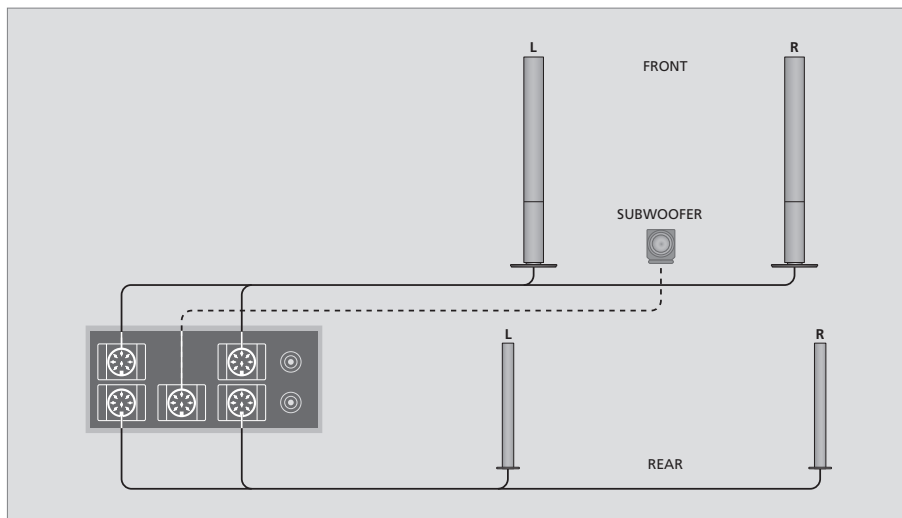

- > Press **MENU** to bring up the TV SETUP menu and press ▼ to highlight OPTIONS.
- > Press **GO** to bring up the OPTIONS menu and press ▼ to highlight SOUND.
- > Press **GO** to bring up the SOUND SETUP menu and press ▼ to highlight SPEAKER TYPE.
- > Press **GO** to bring up the SPEAKER TYPE menu.
- > Press ◀ or ▶ to reveal your speaker type and ▼ to move on to the next speaker set. Choose NONE if no speakers are connected.
- > If you have a BeoLab 2 subwoofer, press ▼ to move the cursor to SUBWOOFER and press ▶ to change the field to YES.
- > Press **GO** to store or **EXIT** to leave the menu without storing.

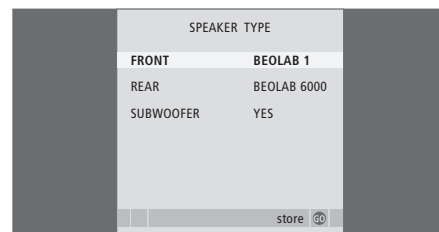

Set speaker distance

Switch on the television from your favourite viewing position. Enter the straight-line distances in metres between your position and the individual speakers.

To set the speaker distances ...

- > Press **MENU** to bring up the TV SETUP menu and press **▼** to highlight **OPTIONS**.
- > Press **GO** to bring up the **OPTIONS** menu and press **▼** to highlight **SOUND**.
- > Press **GO** to bring up the **SOUND SETUP** menu and press **▼** to highlight **SPEAKER DISTANCE**.
- > Press **GO** to bring up the **SPEAKER DISTANCE** menu.
- > Press **▲** or **▼** to move the cursor from speaker to speaker and press **◀** or **▶** to select the approximate straight-line distance in metres between your viewing position and each of the speakers.
- > When you have entered the appropriate speaker distances, press **GO** to store or press **EXIT** to leave the menu without storing.

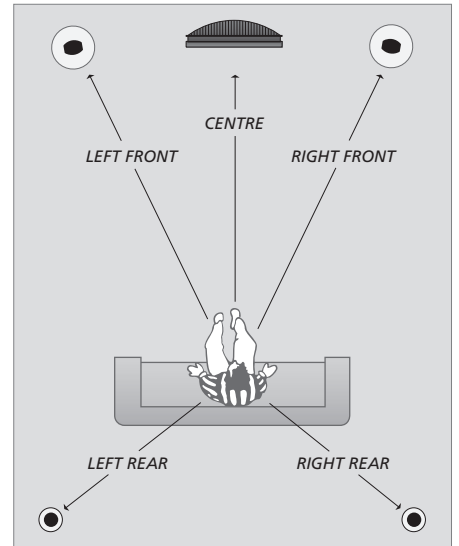

| SPEAKER DISTANCE | |
|------------------|-------|
| CENTRE | 1.0 M |
| LEFT FRONT | 1.0 M |
| RIGHT FRONT | 1.0 M |
| RIGHT REAR | 1.0 M |
| LEFT REAR | 1.0 M |
| store GO | |

You do not have to enter a distance for a BeoLab 2 subwoofer, as the placement of a subwoofer has little impact on the sound.

Calibrate the sound level

When you have connected speakers in a surround sound setup to the television, you must perform a speaker calibration.

A calibration sound is produced alternately in each of the speakers you have connected in your surround sound setup. Your task is to adjust the sound level from all the connected speakers to match the sound level from the centre speaker. You can choose whether you want the sound sequence to occur automatically or manually.

Once you have performed your speaker calibration, you will only need to re-calibrate the speaker sound if you make changes to the setup, for example, if you move one or more of the speakers.

- > Press **MENU** to bring up the TV SETUP menu and press **▼** to highlight **OPTIONS**.
- > Press **GO** to bring up the **OPTIONS** menu and press **▼** to highlight **SOUND**.
- > Press **GO** to bring up the **SOUND SETUP** menu and press **▼** to highlight **SPEAKER LEVEL**.
- > Press **GO** to bring up the **SPEAKER LEVEL** menu. **SEQUENCE** is highlighted.
- > Press **◀** or **▶** to choose between **AUTOMATIC** and **MANUAL**.
- > Press **◀** or **▶** to adjust the speaker sound and **▲** or **▼** to move to another speaker.
- > When you have adjusted the sound for all the speakers in your surround sound setup, press **GO** to store or press **EXIT** to leave the menu without storing.

The sound level from the television speakers functions as your point of comparison with the external speakers and can not be adjusted here.

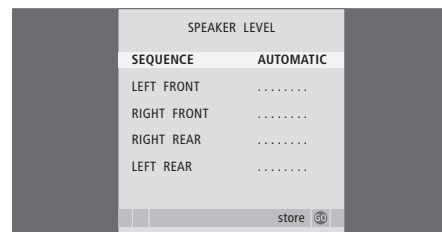

It is not necessary to calibrate subwoofer sound in a surround sound setup. If you still wish to adjust subwoofer sound when your speaker calibration is complete, refer to the section 'Sound adjustments' on page 52.

Sound adjustments

Sound settings are preset at the factory to neutral values which suit most listening situations. However, if you wish, you can adjust these settings to your liking.

You can preset levels for sound volume, bass, treble and a connected BeoLab 2 subwoofer.

In addition, you can switch the loudness feature on or off. The loudness feature compensates for the human ear's lack of sensitivity to high and low frequencies. These frequencies are boosted at low volume levels so that low music becomes more dynamic.

- > Press **MENU** to bring up the TV SETUP menu and press **▼** to highlight OPTIONS.
- > Press **GO** to bring up the OPTIONS menu and press **▼** to highlight SOUND.
- > Press **GO** to bring up the SOUND SETUP menu, ADJUSTMENT is highlighted already.
- > Press **GO** to bring up the SOUND ADJUSTMENT menu.
- > Press **▲** or **▼** to select an item to adjust.
- > Press **◀** or **▶** to adjust the values or choose a setting.
- > Press **▲** or **▼** to move through menu items.
- > Press **EXIT** to store your settings until you switch off your television.
- > Press **GO** to store your settings permanently.

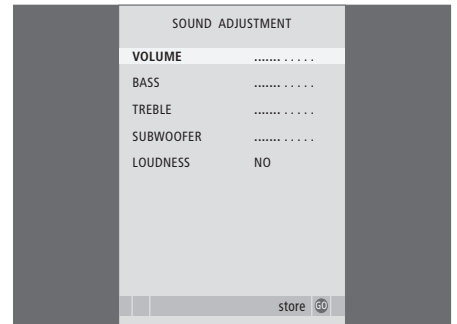

Note that not all items are available if headphones are connected.

Choose a speaker combination

While you are watching a movie or programme, you can choose the speaker combination you wish to switch on, provided that the various sound modes are available in your system.

The television may switch on a speaker combination automatically. This happens if a programme or DVD contains information about the number of speakers to be switched on. You are still free to choose the speaker combination you prefer.

To choose a speaker combination via Beo4...

- > Press LIST on Beo4 until SPEAKER is shown in the Beo4 display.
- > Press the number of the speaker combination you want. The selected speakers cut in automatically.
- > If you want to adjust the sound balance for the programme you are watching, press ▲ or ▼ to adjust the balance between the external front and rear speakers, and press ◀ or ▶ to adjust the balance between the left and right speakers.
- > Press EXIT to remove SPEAKER from the Beo4 display and to return to the source you were using.

Speaker combinations

- SPEAKER 1 ... Sound in the centre speaker only.
- SPEAKER 2 ... Stereo sound in the two front speakers. The BeoLab 2 subwoofer is active.
- SPEAKER 3 ... The centre speaker, front speakers and the BeoLab 2 subwoofer are active.
- SPEAKER 4 ... Enhanced stereo sound in the front and rear speakers. The BeoLab 2 subwoofer is active.
- SPEAKER 5 ... Surround sound from all speakers including the BeoLab 2 subwoofer. For programmes encoded in Surround Sound.

If you have connected only two external front speakers to the television, you can only choose SPEAKER 1–3.

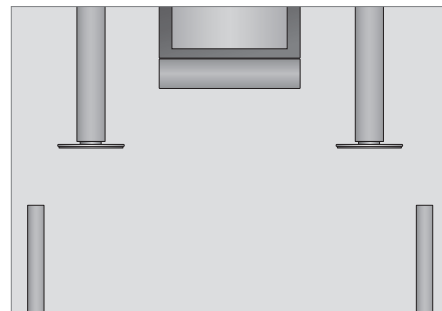

See the name of the active sound system

You can see the name of the active sound system for a source or programme on the screen. However, it is not possible to adjust or preset a sound system.

- > Press **MENU** to bring up the TV SETUP menu and press ▼ to highlight OPTIONS.
- > Press **GO** to bring up the OPTIONS menu and press ▼ to highlight SOUND.
- > Press **GO** to bring up the SOUND SETUP menu and press ▼ to highlight SOUND SYSTEM.
- > Press **GO** to bring up the SOUND SYSTEM menu.

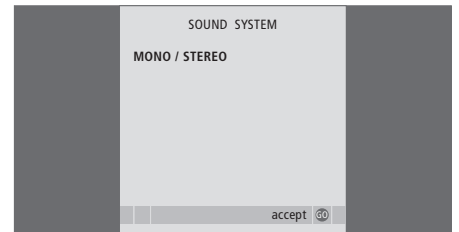

All your Bang & Olufsen products can be connected in a BeoLink system. A complete BeoLink system enables you to distribute sound and picture from one central source throughout the house.

Advanced operation, 5

All you need to know about using your television beyond daily use, such as how to operate timed play and timed standby functions, and a connected set-top box. How to operate a surround sound system.

Tuning and preference settings, 15

Find out how to set up your television for the first time and tune in programs. This chapter also contains information about settings for time, date, stand positions, picture and sound.

Placement, sockets and connections, 35

Find out how to handle and place your television and where the sockets are placed. Find out how to connect a decoder, set-top box or video recorder to your television and how to register extra equipment. How to connect speakers and how to turn your television into a surround sound system, including how to choose speaker combinations.

BeoLink system, 55

- Connect and operate an audio system, 56
- Your television in a link room, 60
- Distribute sound and picture with BeoLink, 62
- Two televisions in the same room, 64
- Customise Beo4, 66

Index, 68

Connect and operate an audio system

If you connect a compatible Bang & Olufsen audio system to the television using a Master Link cable, you obtain the benefits of an integrated audio/video system.

Play a CD on your audio system using your television speakers, or switch on a TV programme and send the sound to your audio system speakers.

Your AV system can be placed together in one room or in two rooms with the television placed in one room and the audio system with a set of speakers placed in another.

If your television is equipped with the optional FM or FM/DAB module, you can disable it, and then it cannot be used as source.

Not all Bang & Olufsen audio systems support integration with the television.

Connect a radio

If you connect an audio system to your television, you must enter the BeoLink menu and set up how the radios should be used:

- > Press **TV** to switch on the television
- > Press **MENU** to bring up the SETUP menu.
- > Press **▼** to move to **OPTIONS**, press **GO** to call up the **OPTIONS** menu.
- > Press **▼** to move to **BEOLINK**, press **GO** to call up the **BEOLINK** menu.
- > Press **▲** or **▼** to move between the menu options and press **◀** or **▶** to change settings.

When an audio system is connected to your television and the built-in radio is enabled, you can choose which radio to use. In general you could say that the primary radio is called up by means of the **RADIO** button, whereas you must use the **AV** button to call up the secondary radio.

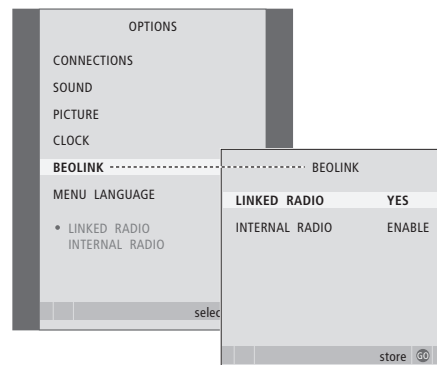

Option setting

If your television has been set up in an AV system, you may need to set it to the correct Option with Beo4. Switch the entire system to standby first.

Option setting for the television

- > While holding the • button on Beo4, press LIST.
- > Let go of both buttons.
- > Press LIST repeatedly to display OPTION? on Beo4 and press GO.
- > Press LIST repeatedly to display V.OPT on Beo4 and then key in the appropriate number (1, 2 or 4).

Option setting for the audio system

- > While holding the • button on Beo4, press LIST.
- > Let go of both buttons.
- > Press LIST repeatedly to display OPTION? on Beo4 and press GO.
- > Press LIST repeatedly to display A.OPT on Beo4 and then key in the appropriate number (0, 1, 2, 5 or 6).

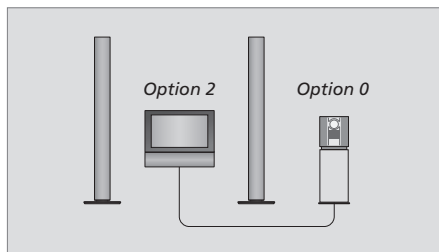

The television and an audio system set up in one room – all speakers are connected to the television.

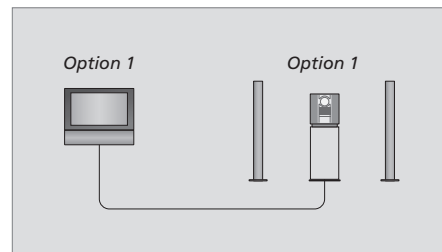

You can choose to set up your television (with or without additional speakers) and the audio system (with a connected set of speakers) in the same room.

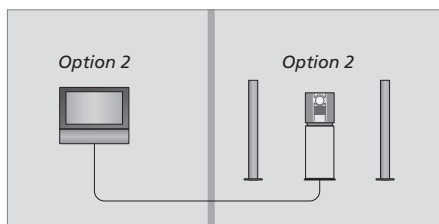

You can choose to set up your audio system in one room, and the television (with or without additional speakers) in another.

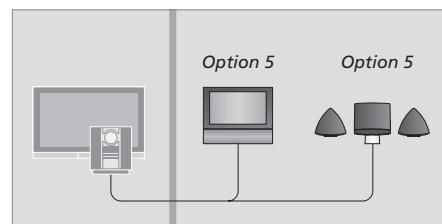

If you set up your television in a link room where an audio system is placed, you must set them to Option 5.

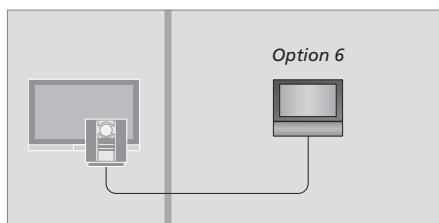

If you set up your television in a link room without an audio system, you must set it to Option 6.

Use an integrated audio/video system

If you integrate your audio system and your television, you can choose a speaker combination appropriate to the current video or audio program, and also record video sound on the audio system.

Video sound recording

If you listen to sound from your television on your Bang & Olufsen audio system's speakers, and your audio system has a tape recorder, you can record television sound on the audio tape recorder. Refer to the Guide enclosed with your audio system for further information.

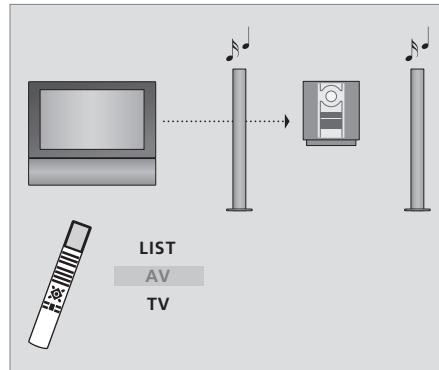

To listen to sound from a television source on your audio system speakers without switching on the screen, press LIST repeatedly to display AV* on Beo4, and then press a source button, such as TV.

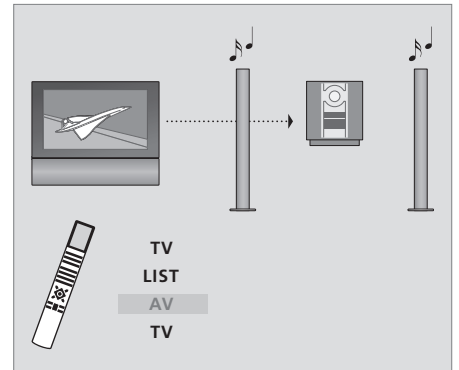

To listen to sound from television on your audio system speakers with the screen switched on, press TV, press LIST repeatedly to display AV*, and then press TV again.

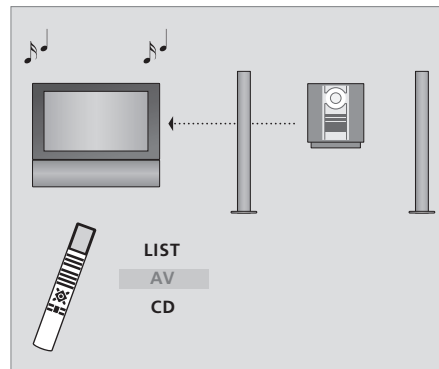

To listen to audio sound on the television speakers, press LIST repeatedly to display AV* on Beo4, and then press an audio source button, such as CD.

**NOTE! In order to display AV on Beo4, you must first add it to the Beo4 list of functions. For further information, refer to the chapter 'Customise Beo4' on page 66.*

Your television in a link room with an audio system

If you set up your television in a link room and enable the internal radio, you can choose which radio you want to listen to. However, you can only use the internal radio in your television, if you have enabled it, as described on page 56.

The setups described on this page illustrate which radio is activated when you have enabled the internal radio and connected a link radio to your television also.

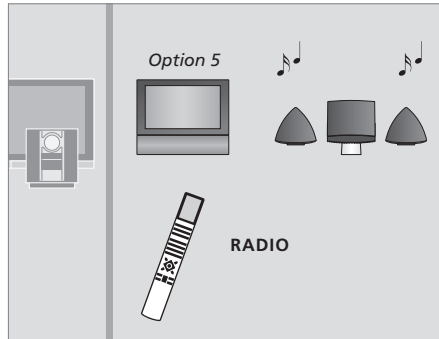

To listen to radio from the audio system, simply press RADIO.

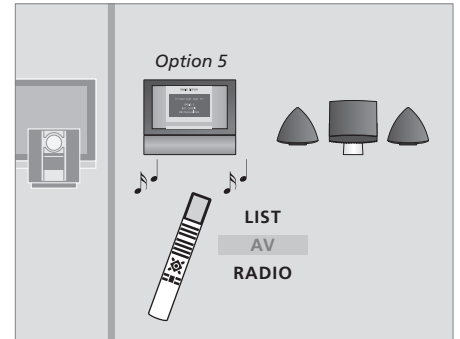

To listen to radio from the built in radio, press LIST repeatedly to display AV on Beo4, then press RADIO.*

Your television in a link room

If you have BeoLink installed in your home and you choose to place your television in a link room, you can operate all connected systems through the television.

You must follow the procedure described below when you connect your television for use in a link room:

- 1 Connect the link room television to the mains
- 2 Using the Beo4 remote control, program the link room television to Option 6*
- 3 Disconnect the link room television from the mains
- 4 Make the link and aerial connections
- 5 Reconnect the link room television to the mains.

Option setting

For your entire system to function properly, it is essential that the television in the link room is set to the correct Option before you connect it to the system in the main room!

To set the link room television to the correct option ...

- > While holding the • button, press LIST.
- > Let go of both buttons.
- > Press LIST repeatedly to display OPTION? on Beo4 and press GO.
- > Press LIST repeatedly to display V.OPT on Beo4 and press 6*.

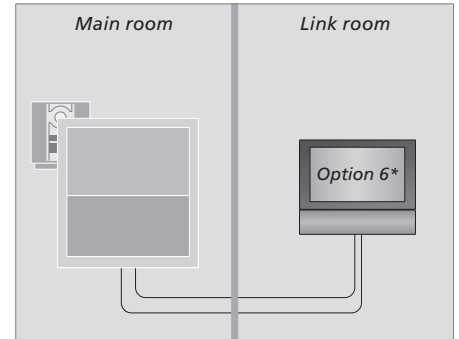

**If you connect the television for use in a link room where other link systems are already connected, such as speakers, you must set the television to Option 5 instead.*

Link room operation

When you are in the link room, you can operate all connected systems with the Beo4 remote control.

Use sources present only in one of the rooms ...

Press the button for the source you wish to use

RADIO

Operate the selected source as usual

Use a main room source – source type present in both rooms ...

Press repeatedly on Beo4 until LINK* is shown in the Beo4 display

LIST

LINK

Press the button for the source you wish to use

TV

Operate the source as usual

Use a link room source – source type present in both rooms ...

Press the button for the source you wish to use

TV

Operate the source as usual

Listen to stereo sound in your link room ...

Usually sound distributed from a main room video source, such as a set-top box, to the link room is transmitted in mono. However, you can select stereo sound:

Press to switch on the television

DTV

Press repeatedly until AV* is shown in the Beo4 display

LIST

AV

Press to activate a source connected to the main room system, such as a set-top box

DTV

While using this function, distribution of other main room sources to other link room systems is not possible.

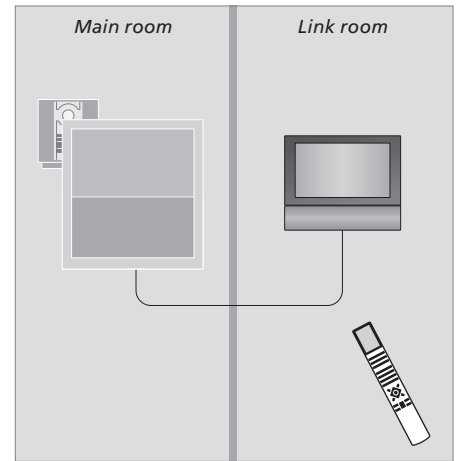

**In order to display LINK and AV on Beo4, you must first add them to the Beo4 list of functions. For further information, refer to the chapter 'Customise Beo4' on page 66.*

Distribute sound and picture with BeoLink

The BeoLink system makes it possible to distribute picture and/or sound to other rooms throughout the house.

For example, you can connect your television in the living room to another video system or set of speakers in another room, thereby making it possible to 'move' the picture or sound to other rooms.

If you have a BeoLink distribution system installed, you can either use your television in the main room, such as a living room, or in a link room, such as a study or bedroom.

Under certain circumstances, it may be necessary to enter modulator settings.

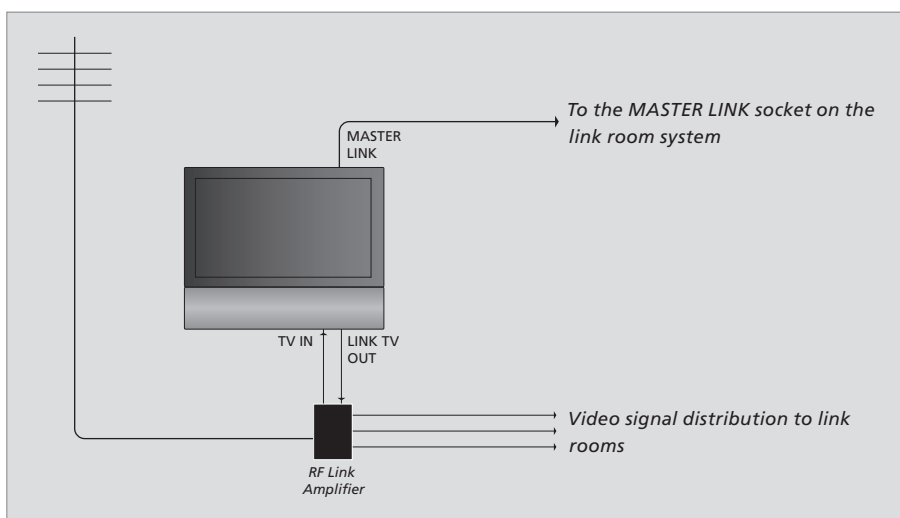

The main room system must be connected to the link room system with a Master Link cable:

- > Connect the Master Link cable to the socket marked MASTER LINK on the television.
- > If you want to distribute video signals as well, connect an ordinary aerial cable to the socket marked LINK TV OUT on the television. Then run the aerial cable to the RF Link Amplifier and the Master Link cable to the link room. Follow the instructions enclosed with the link room equipment.

If an audio system is already connected to the Master Link socket and you wish to connect more equipment, the Master Link cable must be split in two and joined with the cable from the link room using a special junction box. Contact your Bang & Olufsen retailer for assistance.

Digital audio and video signals cannot be distributed from a main room television to the link room system.

NOTE! Groups made on a television in a main room cannot be accessed from a link room television.

System modulator

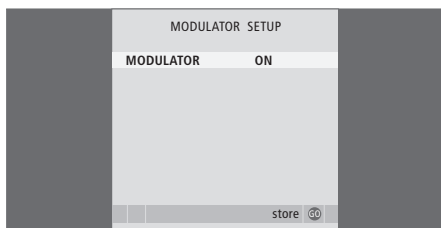

If you have an audio setup, such as a BeoLink Active/Passive, and you choose to set up a non-linkable television in the same room, you must set the system modulator to ON. The factory setting is OFF, which must be used if you are using a linkable Bang & Olufsen television.

To switch on the system modulator ...

- > Press **TV** to switch on the television.
- > Press **MENU** to bring up the TV SETUP menu and press **▼** to highlight TUNING.
- > Press **GO** to bring up the TV TUNING menu, and press **▼** to highlight LINK FREQUENCY.
- > Press **◀** twice, followed by **GO**. The MODULATOR SETUP menu appears.
- > Press **◀** or **▶** to reveal ON.
- > Press **GO** to store the setting, or ...
- > ... press **EXIT** to leave all menus without storing.

Link frequency

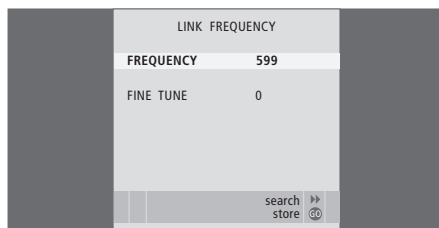

If, for example, a TV program in your area is broadcasted on the same frequency as the BeoLink system uses, 599 MHz, you must tune the system modulator to an unoccupied frequency. When you change the link frequency in the main room system, make sure that the link frequency in the link room system corresponds to it.

To change the link frequency ...

- > Press **TV** to switch on the television.
- > Press **MENU** to bring up the TV SETUP menu and press **▼** to highlight TUNING.
- > Press **GO** to bring up the TV TUNING menu and press **▼** to highlight LINK FREQUENCY.
- > Press **GO** to bring up the LINK FREQUENCY menu. FREQUENCY is already highlighted.
- > Press **◀** or **▶** to find an unused frequency.
- > Press **GO** to store the setting, or ...
- > ... press **EXIT** to leave all menus without storing.

Two televisions in the same room

If you have placed your BeoCenter 6 in a room where you already have a Bang & Olufsen television, and commands from Beo4 can be received by both televisions, you must change the option setting of BeoCenter 6. This prevents simultaneous activation of both televisions.

One remote control for both televisions

For your television to function properly, it is essential that the television is set to the correct Option:

To set your television for Option 4 ...

- > While holding the • button on Beo4, press LIST.
- > Let go of both buttons.
- > Press LIST repeatedly to display OPTION? on Beo4 and press GO.
- > Press LIST repeatedly to display V.OPT on Beo4 and press 4.

Operate your television in Option 4 ...

Normally, you can activate a source, such as TV, simply by pressing the relevant source button on Beo4. However, when you set your television to Option 4, you must do the following:

- > Press LIST repeatedly until LINK* is shown in the Beo4 display.
- > Press a source button, such as TV.

**In order to display LINK on Beo4, you must add it to the Beo4 list of functions.*

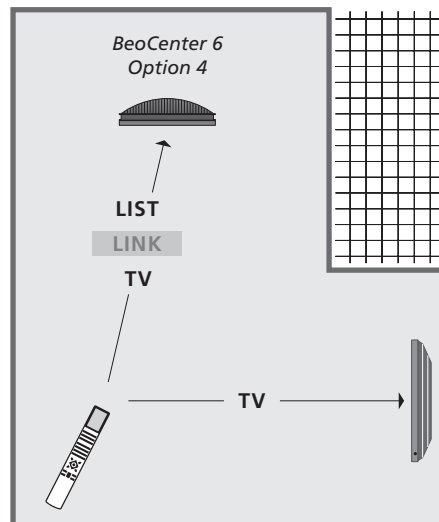

In order to use teletext on a television you have set to Option 4, you must set up Beo4 to 'VIDEO 3', but this limits the Beo4 functions that can be used with televisions set to other Options. For further information refer to the chapter 'Customise Beo4' on page 66.

Customise Beo4

The Beo4 buttons give direct remote control of a large number of television functions, and the Beo4 display gives you access to even more functions.

Whenever a source is displayed on Beo4 (TV, RADIO, etc.), you can press the LIST button and bring up extra functions in the display to help you operate that source, just as if you were calling up extra buttons. You can also switch on extra equipment connected to your television.

You can customise a new Beo4 to suit your television, and change the order in which these extra functions appear when you call them up.

Note that Beo4 contains a list of all of Bang & Olufsen's extra audio and video functions, but only those functions supported by the television work when you call them up in the Beo4 display.

Set up Beo4

The Beo4 is set up for use with BeoCenter 6 from the factory. However, if you buy a new Beo4 you can set this up for your television also.

Press and hold the standby button down •

Press to get access to the Beo4 setup function LIST

Let go of both buttons. ADD? appears in the display ADD?

Press repeatedly to display CONFIG? on Beo4 LIST CONFIG?

Press to be able to select the type of configuration GO

Press repeatedly to display VIDEO? on Beo4 LIST VIDEO?

Press to get access to the video configuration GO

Press repeatedly to display VIDEO 2 on Beo4* LIST VIDEO 2

Press to store the configuration GO

STORED appears, indicating that the configuration has been stored. You leave the Beo4 setup function automatically STORED

*If you have set your television to Option 4, select 'VIDEO 3'.

Add an extra 'button'

When you add a new function to the Beo4 list, you can then bring up this new 'button' in the Beo4 display.

Press and hold the standby button down •

Press to get access to the Beo4 setup function LIST

Let go of both buttons. ADD? appears in the display ADD?

Press to bring up the list of available 'buttons' to add from. The first 'button' appears in the display, it flashes on and off GO

Press to move forwards or backwards in the list of all extra 'buttons' ▲ ▼

Press to add and place the 'button' on its preset position or as the first 'button' in the list, or ... GO

... press to insert the 'button' at a specific position in the list 1 – 9

ADDED appears, indicating that the 'button' has been added. You leave the Beo4 setup function automatically ADDED

Move extra 'buttons'

You can rearrange the order in which the extra 'buttons' appear when you press LIST.

- Press and hold the standby button down •
- Press to get access to the Beo4 setup function **LIST**
- Let go of both buttons. ADD? appears in the display **ADD?**
- Press repeatedly to display MOVE? on Beo4 **LIST**
MOVE?
- Press to bring up the list of extra 'buttons'. The first 'button' appears in the display **GO**
- Press to move forwards or backwards in the list of extra 'buttons' ▲ ▼
- Press to move and place the displayed 'button' as the first in the list, or ... **GO**
- ... press to move the 'button' to a specific position in the list **1 - 9**
- MOVED appears, indicating that the 'button' has been moved. You leave the Beo4 setup function automatically **MOVED**

Remove an extra 'button'

You can remove any of the extra 'buttons' that are available when you press LIST.

- Press and hold the standby button down •
- Press to get access to the Beo4 setup function **LIST**
- Let go of both buttons. ADD? appears in the display **ADD?**
- Press repeatedly to display REMOVE? on Beo4 **LIST**
REMOVE?
- Press to bring up the list of extra 'buttons'. The first 'button' appears in the display **GO**
- Press to move forwards or backwards in the list of extra 'buttons' ▲ ▼
- Press to remove the 'button' shown in the display **GO**
- REMOVED appears, indicating that the 'button' has been removed. You leave the Beo4 setup function automatically **REMOVED**

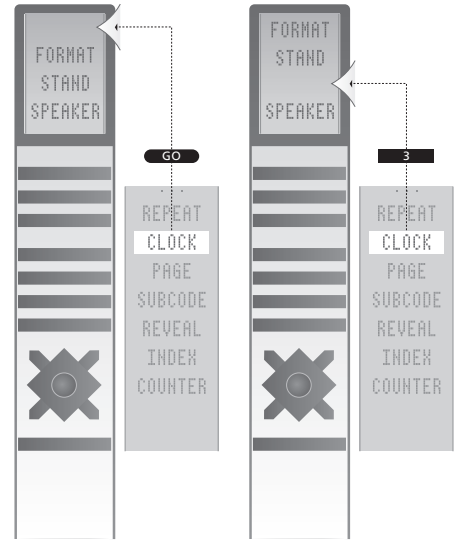

Add an extra 'button' to Beo4, either to the top of the list or to a specific position.

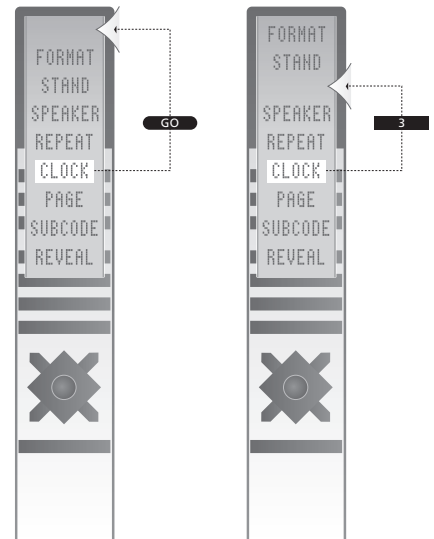

Move extra 'buttons', either to the top of the list or to a specific position.

Beo4 remote control

- Add a 'button' to the Beo4 list, 66
- Changing the Beo4 batteries, *Guide p. 18*
- Cleaning the Beo4, *Guide p. 18*
- Configure Beo4, 66
- Customise Beo4, 66
- Introducing your television and Beo4, *Guide p. 4*
- Move extra 'buttons', 67
- Remove a 'button' from the Beo4 list, 67
- Replace Beo4 batteries, *Guide p. 18*
- Using Beo4, *Guide p. 4*

BeoLink

- Link frequency, 63
- Link room operation, 61
- Master Link socket, 40
- Your television in a link room, 60

Camera

- Connect a Camera, 39
- Copy from a Camcorder to a videotape, 39

Clock

- Set the time and date, 29

Computer monitor

- Adjust picture, 12
- Bring up the computer image on the screen, 12
- Connect a computer, 41

Connections

- Aerial and mains connection, 38
- Audio system – connect to the television, 56
- Camera, 39
- Connections – your television in a link room, 60
- Decoder, 42
- Headphones, 39
- Link room connections, 60
- Loudspeakers, 49
- Register additional video equipment, 46
- Set-top box, 43
- Socket panel, 40
- Sockets for temporary connections, 39
- Video recorder, 44

Contact

- Contact Bang & Olufsen, *Guide p. 19*

Decoder

- Connect a decoder, 42

Displays and menus

- Displayed information and menus, *Guide p. 5*
- On-screen menus, 4

DAB radio

- Add new TV or radio programs, 27
- Adjust DAB aerial, 25
- Adjust tuned DAB programs, 24
- Auto-tuning – first-time setup of your television, 16
- Bring up a list of radio programs, *Guide p. 14*
- Change radio display, 33
- DAB DRC menu, 25
- Delete tuned programs, 21
- Edit tuned programs, 20
- Move tuned programs, 20
- Name tuned programs, 22
- Re-tune via automatic tuning, 26
- See list of all programs, *Guide p. 14*
- Tune in new programs, manual tuning, 24

First-time setup

First-time setup procedure, 16

Format

Change the picture format, *Guide p. 9*

Groups

Create Groups, *Guide p. 12*

Move programs within a Group, *Guide p. 13*

Select programs in a Group, *Guide p. 12*

Headphones

Connect headphones, 39

Language

Change sound type or language, *Guide p. 8*

Choose menu language, 32

First-time setup – choose menu language, 16

Loudspeakers

Change speaker balance or combination,
Guide p. 9

Connect speakers, 49

Place external speakers, 48

Set speaker distance, 50

Sound adjustments, 31

Maintenance

About the screen, *Guide p. 18*

Change Beo4 batteries, *Guide p. 18*

Handling your television, 36

Maintenance of your television, *Guide p. 18*

Master Link

Audio system with your television, 56

Connect your audio system, 56

Option setting, 57

Use integrated audio/video system, 58

Picture

Adjust brightness, colour or contrast, 30

Change the picture format, *Guide p. 9*

Remove the picture from the screen, 30

Pincode

Activate the pincode system, *Guide p. 16*

Change or delete your pincode, *Guide p. 16*

If you have forgotten your pincode, *Guide p. 17*

Use your pincode, *Guide p. 17*

Placement

Set up your television, 36

Set positions for the television to turn to, 28

Turn the television, *Guide p. 7*

Position of television

Set positions for the television to turn to, 28

Turn the television, *Guide p. 7*

Radio

Add new TV or radio programs, 27

Adjust tuned radio programs, 24

Auto-tuning – first-time setup of your
television, 16

Bring up a list of radio programs, *Guide p. 14*

Create Groups of radio programs, *Guide p. 12*

Delete tuned programs, 21

Edit tuned programs, 20

Listen to tuned programs, *Guide p. 14*

Move tuned programs, 20

Name tuned programs, 22

Re-tune via automatic tuning, 26

See list of all radio programs, *Guide p. 14*

Set-top box

Connect a set-top box, 43

Set-Top Box Controller menu, 10

Universal Beo4 operation, 11

Use the set-top box in a link room, 11

Use the set-top box's own menu, 11

Socket panel

Camera and headphones sockets, 39

Socket panel, 40

Sound

Adjust or mute the sound, *Guide p. 8*

Adjust volume, bass or treble, 31

Change sound type or language, *Guide p. 8*

Change speaker balance or combination,
Guide p. 9,

Stand

Determine the centre position – first-time
setup, 18

Set positions for the television to turn to, 28

Turn the television, *Guide p. 7*

Subtitles

Subtitles from teletext, *Guide p. 11*

Surround sound

Adjust speaker balance, 13

Calibrate the sound level, 51

Choose speaker combination, 13, *Guide p. 9*

Connect speakers, 49

Place external speakers, 48

See the name of the active sound system, 54

Set speaker distance, 50

Sound adjustments, 52

Teletext

- Basic teletext functions, *Guide p. 10*
- Day-to-day use of MEMO pages, *Guide p. 11*
- Store favourite teletext pages, *Guide p. 11*

Timer

- Set the television to switch itself on and off, 8
- Set the time and date, 29
- Timed play and timed standby, 8
- View, edit or delete a Timer, 9

Tune

- Add new radio or TV programs, 27
- Adjust tuned programs, 23
- Auto-tuning – first-time setup of your television, 17
- Delete tuned programs, 21
- Move tuned programs, 21
- Name tuned programs, 22
- Re-tune via automatic tuning, 26

TV programs

- Add new TV programs, 27
- Adjust tuned programs, 23
- Auto-tuning – first-time setup of your television, 16
- Bring up a TV list, *Guide p. 6*
- Delete tuned programs, 21
- Edit tuned programs, 20
- Move tuned programs, 21
- Name tuned programs, 22
- Re-tune via automatic tuning, 26
- Select a TV program, *Guide p. 6*

Wake-up Timer

- Enter a Wake-up Timer, 6
- Check or delete a Wake-up Timer, 7
- Set the time and date, 29



Waste Electrical and Electronic Equipment (WEEE) – Environmental protection

The European Parliament and the Council of the European Union have issued the Waste Electrical and Electronic Equipment Directive. The purpose of the Directive is the prevention of waste of electrical and electronic equipment, and to promote the reuse and recycling and other forms of recovery of such waste. As such the Directive concerns producers, distributors and consumers.

The WEEE directive requires that both manufacturers and end-consumers dispose of electrical and electronic equipment and parts in an environmentally safe manner, and that equipment and waste are reused or recovered for their materials or energy. Electrical and electronic equipment and parts must not be disposed of with ordinary household refuse; all electrical and electronic equipment and parts must be collected and disposed of separately.

Products and equipment which must be collected for reuse, recycling and other forms of recovery are marked with the pictogram shown.

When disposing of electrical and electronic equipment by use of the collection systems available in your country, you protect the environment, human health and contribute to the prudent and rational use of natural resources. Collecting electrical and electronic equipment and waste prevents the potential contamination of nature with the hazardous substances which may be present in electrical and electronic products and equipment.

Your Bang & Olufsen retailer will assist with and advise you of the correct way of disposal in your country.

Small products may not always be marked with the pictogram in which case this is present in the instructions for use, on the guarantee certificate and printed on the packaging.

CE *This product fulfils the conditions stated in the EEU directives 89/336 and 73/23.*

Technical specifications, features and the use thereof are subject to change without notice.

